

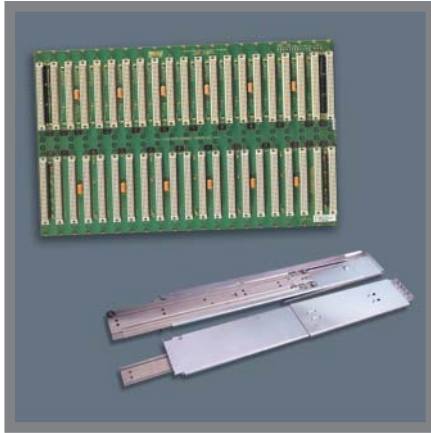

RUGGED SYSTEMS
12R1/12R2/12RC

ATR ENCLOSURES



ACCESSORIES

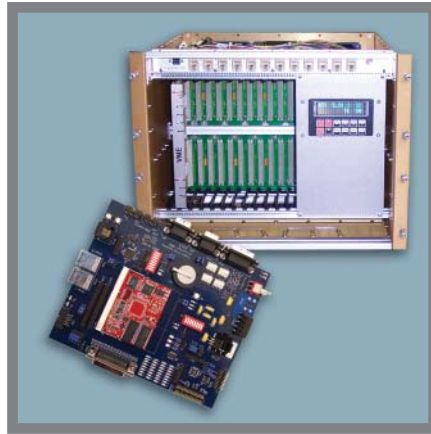

SHELF MANAGEMENT

BACKPLANES

Rugged COTS: Products and Services

Elma Electronic

ABOUT ELMA

Founded in 1962, Elma is an industry innovator in the design and manufacture of electronic enclosures and passive electronic components. Elma enjoys a leading position in the VME/VME64x, VXI, VXS, VPX, PXI, cPCI, ATCA, MicroTCA and Rugged COTS packaging markets.

Based in Wetzikon, Switzerland and Fremont, California, Elma is a global leader in electronic enclosures and components. The company has facilities and representatives in over 24 countries. Elma has a broad base of customers in diverse industries such as telecommunications, industrial control, medical electronics, military and defense.

Elma strives to provide products superior in quality, reliability, performance, and consistently presents new, innovative designs to the market. Elma's product line encompasses well over 16,000 parts, including enclosures, cabinets, high quality switches, LED arrays, knobs and much more. Elma also offers design and integration services backed by responsive and knowledgeable technical support. Elma's leading quality level is reached through training of all employees and following of systematic procedures per ISO 9001 standards to which Elma has been registered.

CAPABILITIES

- Manufacturing
- Agency Certification
- Verification Testing
- EMC Testing
- Thermal Testing
- System Integration
- Simulation/Characterization
- Customization

WHY CHOOSE ELMA?

Flexibility

Elma tailors solutions to individual applications to ensure fast and cost-effective results.

Experience

Extensive practical experience in packaging electronic systems is used to minimize the time taken to develop new customized solutions without compromising system performance or reliability.

Compatibility

Because the two key electromechanical components - enclosures and backplanes - are made in-house, Elma guarantees compatibility, consistency and reliability.

Global Resources

With manufacturing in Europe, Asia and the USA, customers benefit from local service backed by global resources.

ELMA PRODUCT DIVISIONS

Enclosures & Components



Backplanes

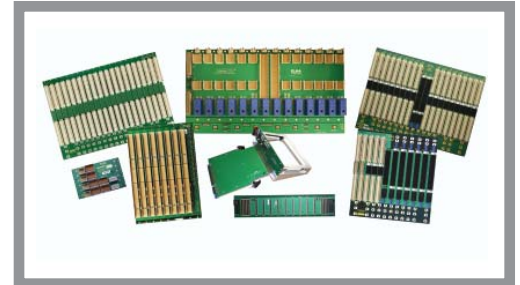

System Platforms



Switches, Knobs & LEDs



Cabinets



Index

Elma Corporate Profile	2
12R Rugged COTS Overview	3
12R1 Low Weight Rugged Chassis	
12R1 Overview	4
12R1 Products	5
12R1 Order Key	6
12R2 Rugged Chassis	
12R2 Overview	7
12R2 Products	9
12R2 Order Key	25
12RC Conduction Cooled Rugged Chassis	
12RC Products	26
ATR Products	
Overview	27
ATR Products	30
ATR Products, Conduction Cooled	31
ATR Tray	31
ATR Order Key	32
Related Products	
Backplanes	33
Accessories - Slide Rails	34
Accessories - Voltage Monitor	35
Accessories - System Monitor	35
Accessories - Other	36
Rugged Cabinets	36
Concept Chassis	37
Applications	37
Services	
Customization	37
Applications	37
Verification Testing	38
Thermal Simulation	39
MIL-STD Testing	40
System Integration	41

12R Series Rugged COTS Chassis

PRODUCT OVERVIEW

The COTS 12R series is a high quality and cost-efficient rugged package for all VME/VME64x, VXS, VPX, CompactPCI and CompactPCI Express applications. The rugged product line includes 2U-14U models for both 6U and 9U cards.

Intended to withstand the demands of a military environments, the 12R series is designed to meet benchmark military standards. To comply with MIL-STD-461D, the 12R platform uses electrostatic dust filters, honeycomb EMI filters, braided gasketing, and metal impregnated flat gaskets to seal off every external opening and seam. The rugged designs meet the requirements for shock and vibration according to MIL-STD-167, MIL-STD-810F and MIL-STD-910D. Test reports and performance specifications are available upon request. All 12Rs are compliant to IEEE 1101.1/10/11 mechanical specifications and IEEE 1101.2 for conduction cooled applications and can accept up to 20 boards. The 12R series are built from aluminum sheets and extrusions. The parts are joint together by spot-welding, rivetting and stainless steel screws. All removable covers are equipped with captive screws. Furthermore, the 12R series are equipped with MIL-grade components, system monitoring LEDs, powerful cooling systems, and are available with fix mounted or shock isolated card cages and drive bays.

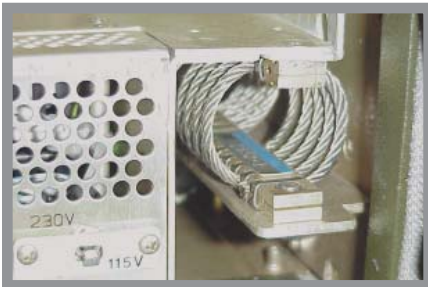

Shock coil isolators

SHOCK & VIBRATION

Every piece of electronic equipment needs to be able to withstand the physical demands of the environment in which it is to be used. In order to protect the equipment and its contents from its insidious effects, Elma uses passive isolation systems such as elastomeric dampers, rope coil isolators and air springs. Most commonly incorporated are rope coil isolators that when deflected, friction between the wire strands produces a damping effect. They offer large deflections in relation to their size, they are also not affected by temperature extremes and resist attack by solvents, chemicals, ozone, etc.



I/O Cabling

EMC

Electromagnetic Interference (EMI) is of paramount importance, especially in a military environment with mission critical applications where spurious emissions can seriously impair a system's integrity. Elma commonly integrates shielding gaskets into the enclosure design to provide a continuous conductive ground contact surface for all removable panels. Thus, sealing all apertures of any size. The gasket is a braided wire mesh with elastomer core in a compression configuration under a flat panel. Closely spaced screws preserve the shielding effectiveness of the enclosure. Line filters are also incorporated that provide a high degree of attenuation (insertion loss) to conducted common mode (line to ground) and differential mode (line to line) emissions and meets MIL-STD-461D. Other options such as integrating honeycomb's EMC filters on all air intake and air exhaust openings, high-grade power supplies that meet or exceed the conducted emissions, and shielded connectors and cable assemblies for I/O cabling requirements. Elma is also careful to employ proper grounding techniques and adequate number of ground points, provide careful selection of components like fans, power on/off switches, indicator LEDs etc. based on their shielding effectiveness or compliance to MIL-STD-461D.



Louvred panels

I/O CABLING

I/O cabling is a key component for almost all enclosures, enabling them to interact with a variety of equipment. The number of cables, the type of connectors, the bend radius required and the routing are all analyzed and evaluated before the design begins. Cable channels or clamps are provided to manage the cable bundle and keep it from interfering with the air flow and access to internal components. A patch panel approach to mounting of the connectors on the rear panel lends tremendous flexibility to the cabling configuration while at the same time, facilitating easy maintenance.

OTHER ELEMENTS

Elma also incorporates many other design elements into the rugged chassis. This includes using stainless steel hardware, conformal coating, and galvanically compatible materials when harsh environments demand them. Other tactics to limit salt fog, fungus and moisture corrosion include hermetically sealed power switches, reset switches and other actuators. Elma's optional drip-proof louvred panels meet IP53 according to IEC 60529. Elma chooses long lasting components to maximize MTBF and minimize MTTR.

12R1 Rugged Chassis - Low Weight



FEATURES

- VME/VME64x, VXS, VPX and cPCI compatible
- Ideal for airborne applications where weight is a premium
- 20-25% less weight than comparable rugged chassis
- 2U-10U heights, horizontal or vertical card orientation options
- Complete EMC integrity via braided gasketing and honeycomb filtering, blind-riveting design
- Rugged chassis shell made of aluminum frames and extruded profiles
- 350-1400 watt power supplies
- 90 - 264 V AC input, 47 - 500 Hz with optional 28V/48V DC input
- Wide range of backplane options 2-20 slots
- Compliant to IEEE 1101.10/11 mechanical specifications
- Configurable IO patch panel on rear
- Rear mounted fans (pull-configuration) standard
- Standard voltage and system monitoring LEDs
- Shelf management option
- Tested for shock, vibration, and structural integrity
- Withstands 15 G's 11ms (shock and vibration resistance)
- Custom configurations available

PRODUCT INFORMATION

The 12R1 platform is a lighter version of the 12R2 platform and is used for rugged applications with weight restrictions and less stringent shock and vibration requirements. The modular 12R1 platforms range from 2U to 10U height with horizontal and vertical board orientations. The all-aluminum shell design consists of extrusion and sheet metal, joint together with stainless steel screws. The chemical conversion coating provides corrosion protection and electrical conductivity. Custom paint finishes are also available. A hinged front panel ensures unobstructed access to boards and drives. Located on the rear is a large patch panel for I/O connection. Exceptional front-to-rear cooling is achieved by a rear evacuative cooling system employing high CFM blowers. Additional fans may be installed under the card cage in applications with high impedance boards. To meet IP53 (spray water) according to IEC 60529, louved air intake and exhaust openings are available upon request.

12R1 SPECIFICATIONS

PHYSICAL		ELECTRICAL		ENVIRONMENTAL	
Depth	22", 25"	Frequency	47-500Hz	Operating Temp.	0°C to 65°C
Heights	3U (8.71") 7U (13.96") 10U (17.46") Custom	Voltage Input	90-264 VAC 28/48 VDC	Storage Temp.	-20°C to 85°C
Width	17.1" (19" Rack Mount)	Power Outputs	300W-14000W +5V, +3.3V, +/-12V	Humidity	0 to 95%, non-condensing
Weight	3U 45 lb. Typ. 7U 60 lb. Typ. 10U 70 lb. Typ.			Altitude	-1,200 to 18,000 Ft.
				Shock	15Gs 11ms
				Vibration	2.5Gs RMS 15 to 2000Hz
				Acceleration	3Gs w/o disk
				Sand and Dust	Blowing
				Salt/Fog	Limited
				Fungus	Limited

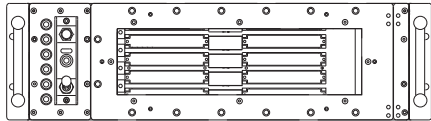

Description	Order Number
<ul style="list-style-type: none"> ■ 3U h x 25" d ■ Holds 5, 6U x 160mm cards, shock isolated, horizontal ■ 5 slot VME64x backplane w/P0 ■ Holds 1 x 3.5" and 1 x 5.25" HH device ■ 350 watt, 90-264VAC Fixed PSU, 47-500 Hz 	<p>12R105OPXX38N5HCB4</p>

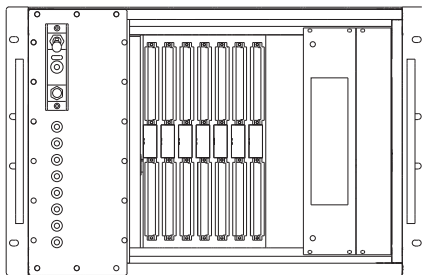

Description	Order Number
<ul style="list-style-type: none"> ■ 7U h x 22" d ■ Holds 5, 6U x 160mm cards, shock isolated, vertical ■ 7 slot VME64x backplane w/P0 ■ Holds 1 x 3.5" and 1 x 5.25" HH device ■ Fixed mount devices ■ 750 watt, 90-264VAC Fixed PSU, 47-500 Hz 	<p>12R107OP9F78N5VGD</p>

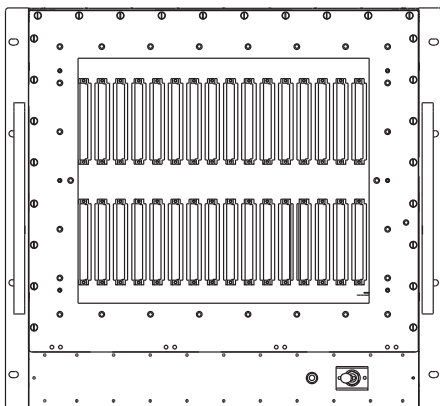

Description	Order Number
<ul style="list-style-type: none"> ■ 10U h x 22" d ■ Holds 5, 6U x 160mm cards, shock isolated, vertical ■ 20 slot VME64x backplane w/P0 ■ Holds 1 x 3.5" and 1 x 5.25" HH device ■ 750 watt, 90-264VAC Fixed PSU, 47-500 Hz 	<p>12R120PXA8Y5VCJ2</p>

12R1 Order Key

1 2 R 1              

PRODUCT
CODE

SLOTS

BP BARE BOARD

BP CONNECTORS

DRIVES

DEVICE MOUNTING

HEIGHT

WIDTH

CARD CAGE



DEPTH

CARD ORIENTATION

PSU INPUT

PSU OUTPUT

SHIELDING

  NUMBER OF SLOTS BP
00-20: Single BP AY-YA: Split
Example: 7 slot = 07
Example: 12 + 9 = L1

 BP BARE BOARD
A = CPCI (RSS), 6U
K = VITA 31.1
L = VXS (DS)
M = V64, J12 mono, 3 row
N = VME64X, 6U
O = VME64X, 7U
P = VPX, 6U (VITA 46)
W = VPX, 3U (VITA 46)
S = VXS (SS)
T = VXS (Mesh)
U = CPCI Express, 3U
X = No BP installed
Z = Custom

 BP CONNECTOR CONFIG. J1/J2/P0
L = 5 row, w/o P0, w/ RT-2
M = 3 row, J1 flush, J2 13mm
N = 3 row, J1/J2, 17mm
O = 5 row, w/o PO
P = 5 row, w/ PO
Q = 3 row, 13mm
R = 3 row, 17mm
S = RT-2 (J0-J6) 6U
U = RT-2 (J0-J2) 3U
D = CPCI (P1 & P2 S; P3, P4, P5 L)
X = No connectors
Z = Custom

 DRIVES
1 = 1 x 3.5"
2 = 2 x 3.5"
3 = 1 x 5.25" HH
4 = 2 x 5.25" HH
5 = 4 x 5.25" HH
6 = 2 x 3.5", 1 x 5.25" HH
7 = 1 x 3.5", 2 x 5.25" HH
8 = 2 x 3.5", 2 x 5.25" HH
9 = 1 x 3.5", 1 x 5.25" HH
A = 1 x 2.5", 1 x CDROM (SL)
B = 2 x 2.5"
C = 6 x 5.25" HH
X = Not installed

 DEVICE MOUNTING
F = Fixed mount devices
I = Shock isolated devices
X = N/A

 HEIGHT
2 = 2U
3 = 3U
4 = 4U
5 = 5U
6 = 6U
7 = 7U
8 = 8U
A = 10U

 WIDTH
8 = 84T

 CARD CAGE
Y = Fixed w/ Rear I/O
N = Fixed no Rear I/O
F = Isolated w/ Rear I/O
I = Isolated no Rear I/O

 DEPTH
3 = 300mm - 399mm
4 = 400mm - 499mm (22")
5 = 500mm - 599mm (25")

 CARD ORIENTATION
V = Vertical
H = Horizontal
T = Top Load

 PSU INPUT
C = 90-264VAC (Fixed)
G = 90-264VAC (Plug in)
H = 48VDC (Plug in)
I = 28VDC (Plug in)
K = 48VDC (Fixed)
M = 48VDC (2 x HS, N+1)
N = 24VDC (Fixed)
O = 24VDC (2 x HS, N+1)
P = 90-264VAC (2 x HS, N+1)
Q = MIL-STD-704A, 28VDC
R = MIL-STD-704A, 90-230VAC
X = No PSU

 PSU OUTPUT
(Note: Not all PSU combinations available)
1 = 150 watt (w/o 3.3V)
2 = 250 watt (4U, 6U or Fixed)
3 = 300 watt (4U/6U, ATX)
4 = 350 watt (6U x 8T, Plug in)
5 = 350 watt (Brick, w/o 3.3V)
6 = 500 watt (Brick, w/o 3.3V)
7 = 300 (4U or 6U, PS2 Hot Swap)
8 = 500 watt (6U x 4T, Plug in)
9 = 750 watt (Brick, w/o 3.3V)
A = 250 watt (Brick, w/ 3.3V)
B = 300-500 watt (Brick, w/3.3V)*
C = 500 watt (Brick, w/3.3V)
D = 750 watt (Brick, w/3.3V)
E = 900 watt (2 x Brick, w/3.3V)
F = 1000 watt (Brick, w/ 3.3V)*
G = 1200 watt (Brick, w/ 3.3V)*
H = 1400 watt (Brick, w/3.3V)*
X = Not installed

 SHIELDING LEVEL
2 = Level 2
4 = MIL-STD-461
X = Not installed

12R2 Rugged Chassis



FEATURES

- VME, VME64x, VXS, VPX, cPCI and MicroTCA compatible
- MIL-grade components
- Tested for shock, vibration, and structural integrity
- Proven performance for multiple military and defense applications
- Ideal for airborne, shipboard and ground mobile programs
- All products feature multiple configurations and are customizable
- Withstands 25 G's (shock and vibration resistance)
- Shelf management optional
- Custom configurations available

PRODUCT OVERVIEW

The 12R2 COTS chassis comes in 5U to 14U heights in horizontal and vertical orientations. A wide range of backplanes in various slot sizes is available in VME, VME64x, VXS, VPX, CompactPCI or MicroTCA architectures.

The 12R2 enclosure system integrates pre tested, standardized enclosure modules with off-the-shelf ruggedized components to include; power supplies, fans, and backplanes, to meet a wide range of customer requirements. The standard off-the-shelf parts; aluminum flat frames and covers, ruggedized side plates, cross-functional extruded profiles, standard electrical components and wire harnesses, ensure performance and reduce lead-time. The 12R2 has MIL-grade components, system monitoring LEDs, and an optimal cooling system to handle a harsh military environment. To meet EMC, the units incorporate honeycomb filters, braided gasketing and metal impregnated gasket sheets to seal off every external seam.

Because system functionality is the most critical requirement of the COTS initiative, Elma baseline tested our design approach to MIL-STD: 810F, 167, 901D and 461, to insure the 12R2 could withstand a military environment. These tests confirm that the 12R2 is a packaging system that has been successfully deployed in shipboard, airborne and ground mobile applications.

12R2 SPECIFICATIONS

PHYSICAL		ELECTRICAL		ENVIRONMENTAL		
Depth	22", 25"	Frequency	47-500Hz	Operating Temp.	0°C to 65°C	
Heights	5U (8.71")	Voltage Input	90-264 VAC	Storage Temp.	-20°C to 85°C	
	8U (13.96")		28/48 VDC	Humidity	0 to 95%, non-condensing	
	9U (15.71")		Power	350W-1000W	Altitude	-1,200 to 18,000 ft.
	10U (17.46")	Outputs		+5V, +3.3V, +/-12V	Shock	25Gs 11ms
	12U (20.96")			Vibration	4.0Gs RMS 15 to 2000Hz	
	14U (24.47")	Acceleration	4.5Gs w/o disk			
Width	17.1" (19" Rack mount)			Sand and Dust	Blowing	
Weight	5U 60 lb. Typ.			Salt/Fog	Limited	
	8U 75 lb. Typ.			Fungus	Limited	
	9U 80 lb. Typ.					
	9U(PCI) 85 lb. Typ.					
	10U 85 lb. Typ.					
	12U 100 lb. Typ.					
14U 115 lb. Typ.						

12R2 Design Features

The 12R2 rugged COTS design combines extruded profiles and the rugged benefits of standard aluminum frames and captive hardware. This innovative design bases the entire chassis around the custom ruggedized side plate. Spot-welded to a 3mm thick aluminum plate are front, rear, top and bottom extruded aluminum profiles. The flexibility of the extrusions allows modification of the entire chassis with standard, off-the-shelf aluminum frames, ensuring quick delivery and minimal engineering effort. The final product is a shell that can and has easily passed MIL-STD-810F, MIL-STD-167 and MIL-STD-901D shock and vibration tests.

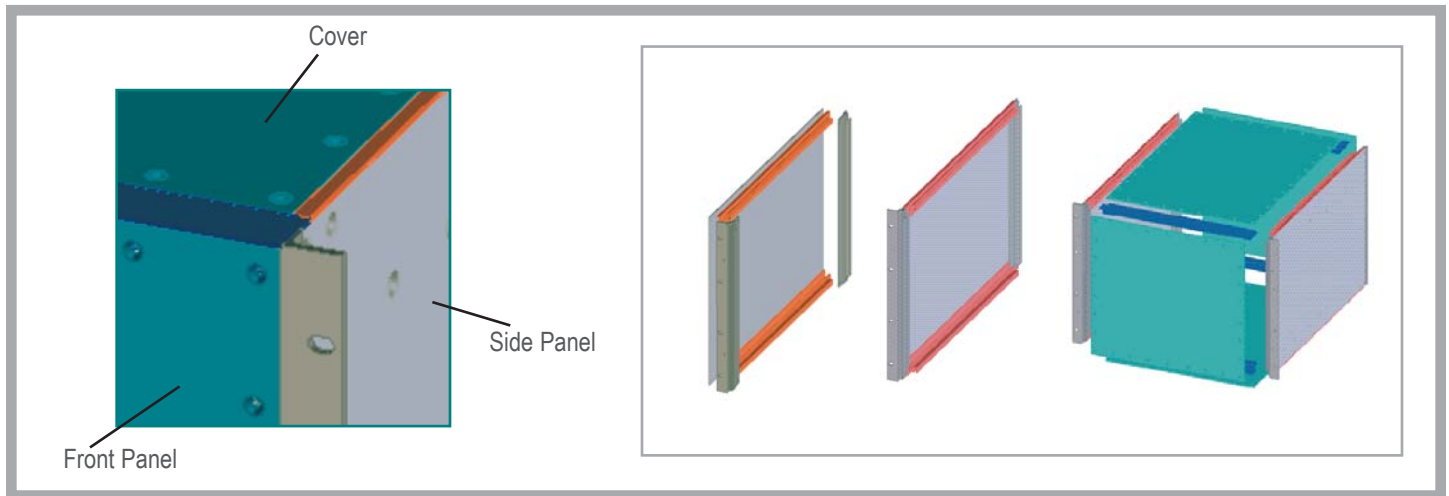

The coverset is 3mm thick and has custom, stainless steel, captive screws installed. Each mating extrusion has an EMC gasket channel and a T-channel that accommodates the rugged stainless steel tapped strip. The 4mm thick rear frame is designed to give maximum available I/O space for each size; each chassis comes with a standard 1.5mm thick blank patch panel. For corrosion resistance, every aluminum part in the 12R2 chassis has a protective yellow chemical conversion coating per MIL-C-5541E Class 3.

The 12R2 offers a superior EMC package. Designed to meet EMI requirements per MIL-STD-461D, the 12R2 uses MIL grade EMC line honeycomb filters, braided gasketing, and metal impregnated flat gaskets to seal off every external seam.

The 12R2 integrates COTS MIL-grade components and a standard wire harness to ensure a high quality, rugged electrical turnkey system without the associated engineering and delivery problems common in today's COTS market. The harnesses and components have been designed and selected to maximize the system options from standard configurations.

EXPLODED VIEWS

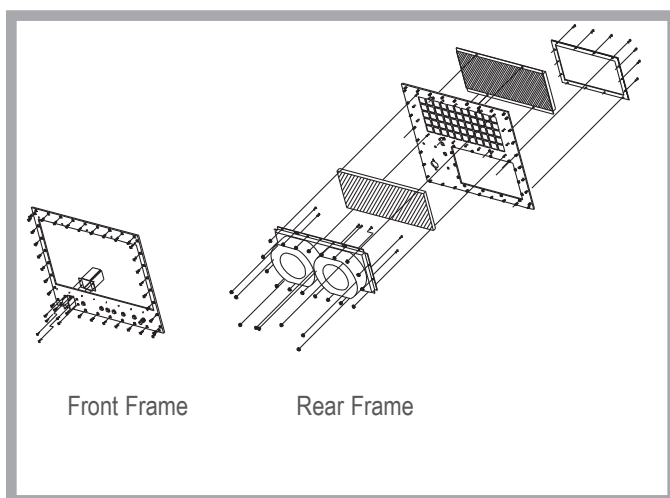

CROSS SECTIONS

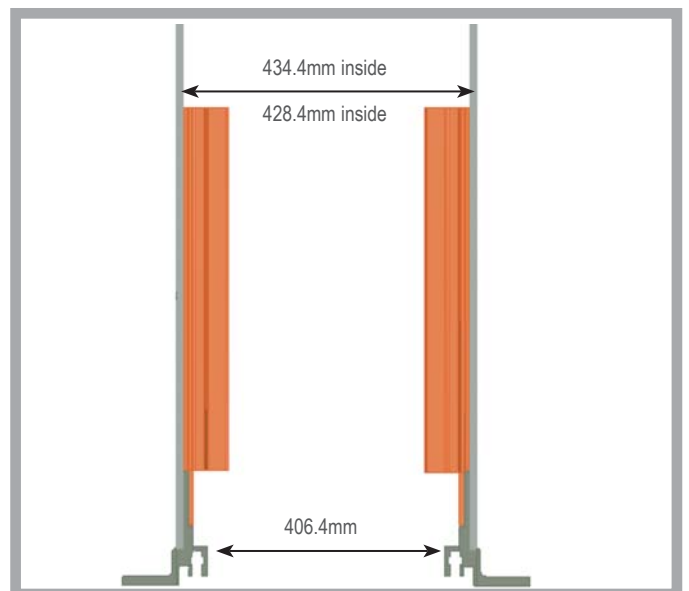

12R2 5U, Front Loaded



FEATURES

- VME, VME64x, VXS, VPX, cPCI or MicroTCA compatible
- 19" rackmount per IEC60297 (slide mounting optional), horizontal
- 5U H x standard depths: 22" and 25"
- 2-7 slot, IEEE 1101.10/.11 compliant card cages
- Optional shock isolated cards cage and device mounting
- Front to rear evacuative cooling (350 LFM @ .1" H2O)
- Custom rear I/O patch panel (rear I/O cards optional)
- MIL grade components
- Front mounted LEDs for; voltage monitoring, fan fail and over temp
- 350 to 500 watt PSU options
- Input options: 90-264VAC Fixed PSU, 47-500 Hz, 28/48VDC

PRODUCT INFORMATION

The 5U, 12R2 is designed to meet the harsh environments of shipboard, airborne, and ground mobile applications per MIL-STD's. The low profile makes it ideal when space is a premium. Highly configurable, the unit can be ordered with choice of VME, VME64x, VXS, VPX, CPCI or MicroTCA, fixed or shock isolated card cage, device mounting, 350 to 500 watt PSU, AC or DC input and custom I/O patch panel. Available in both 22" and 25" depths the unit holds up to 7, horizontally loaded cards (fixed). Airflow is front to rear utilizing high volume fans. Shock isolated versions are designed to attenuate 25G shock inputs to the chassis to less than 10Gs at the card cage. All components, materials and design concepts are chosen to meet the applicable MIL-STD environments. The units come completely assembled and wired.

ORDERING INFORMATION

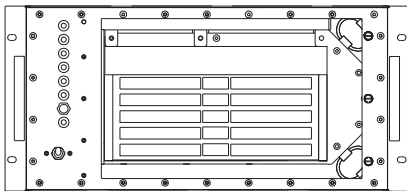

Description	Order Number
<ul style="list-style-type: none"> ■ 5U h x 22" d ■ Holds 5, 6U x 160mm cards, shock isolated, horizontal ■ Rear I/O patch panel ■ 5 slot VME64x backplane w/P0 ■ Holds 1 x 3.5" and 1 x 5.25" HH device ■ 350 watt, 90-264VAC Fixed PSU, 47-500 Hz ■ 1 x 235cfm, HV fan 	12R205OP9I58I5HCB4

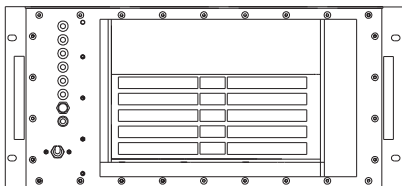

Description	Order Number
<ul style="list-style-type: none"> ■ 5U h x 22" d ■ Holds 7, 6U x 160mm cards, fixed mounted, horizontal ■ 7, 6U x 80mm, rear I/O cards ■ 5 slot VXS mesh backplane ■ Holds 1 x 3.5" and 1 x 5.25" HH device ■ 350 watt, 90-264VAC Plug in PSU, 47-500 Hz ■ 1 x 500cfm, HV fan 	12R205TLXX58Y5HG54

LINE DRAWINGS

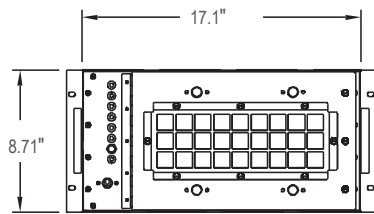

Front View
(door closed)

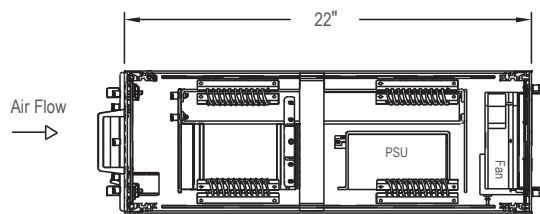

Right Side View
(with side plate removed)

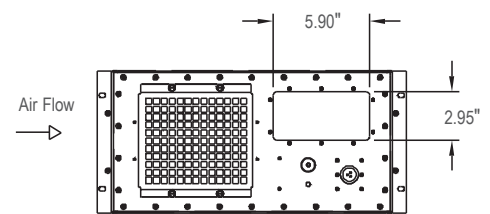

Rear View

CUSTOM CONFIGURATIONS

1 2 R 2 ■ ■ ■ ■ ■ ■ 5 8 ■ ■ H ■ ■ ■

■ NUMBER OF SLOTS BP

00-20: Single BP AY-YA: Split
Example: 7 slot = 07
Example: 12 + 9 = LI

■ BP BARE BOARD

A = CPCI (RSS), 6U
K = VITA 31.1
L = VXS (DS)
M = V64, J12 mono, 3 row
N = VME64X, 6U
O = VME64X, 7U
P = VPX, 6U (VITA 46)
W = VPX, 3U (VITA 46)
S = VXS (SS)
T = VXS (Mesh)
U = CPCI Express, 3U
X = No BP installed
Z = Custom

■ BP CONNECTOR CONFIG. J1/J2/P0

L = 5 row, w/o P0, w/ RT-2
M = 3 row, J1 flush, J2 13mm
N = 3 row, J1/J2, 17mm
O = 5 row, w/o PO
P = 5 row, w/ PO
Q = 3 row, 13mm
R = 3 row, 17mm
S = RT-2 (J0-J6) 6U
U = RT-2 (J0-J2) 3U
D = CPCI (P1 & P2 S; P3, P4, P5 L)
X = No connectors
Z = Custom

■ DRIVES

1 = 1 X 3.5"
2 = 2 X 3.5"
3 = 1 X 5.25" HH
4 = 2 X 5.25" HH
6 = 2 X 3.5", 1 X 5.25"HH
7 = 1 X 3.5", 2 X 5.25"HH
9 = 1 X 3.5", 1 X 5.25"HH
A = 1 x 2.5", 1 X CDROM (SL)
B = 2 x 2.5"
D = 1 x slim line CDROM
X = Not installed

■ DEVICE MOUNTING

F = Fixed mount devices
I = Shock isolated devices
X = N/A

■ HEIGHT

5 = 5U

■ WIDTH

8 = 84T

■ CARD CAGE

Y = Fixed w/ Rear I/O
N = Fixed no Rear I/O
F = Isolated w/ Rear I/O
I = Isolated no Rear I/O

■ DEPTH

4 = 400mm - 499mm
5 = 500mm - 599mm (22")
6 = 600mm - 699mm (25")
7 = 700mm - 799mm

■ CARD ORIENTATION

H = Horizontal

■ PSU INPUT

C = 90-230VAC (Fixed)
G = 90-230VAC (Plug In)
H = 48VDC (Plug In)
K = 48VDC (Fixed)
M = 48VDC (2 x HS, N+1)
N = 28VDC (Fixed)
O = 28VDC (2 x HS, N+1)
P = 90-230VAC (2 x HS, N+1)
Q = MIL-STD-704A, 28VDC
R = MIL-STD-704A, 90-230VAC
S = Custom
X = No PSU

■ PSU OUTPUT

(Note: Not all PSU combinations available)

1 = 100-199 watts (w/o 3.3V)
2 = 200-299 watts (w/o 3.3V)
3 = 300-399 watts (w/o 3.3V)
4 = 400-499 watts (w/o 3.3V)
5 = 500-599 watt (w/o 3.3V)
6 = 600-699 watt (w/o 3.3V)
7 = 700-799 watt (w/o 3.3V)
8 = 800-899 watt (w/o 3.3V)
A = 100-199 watt (w/ 3.3V)
B = 200-299 watt (w/3.3V)
C = 300-399 watt (w/3.3V)
I = 900-999 watt (w/3.3V)
J = 1000-1099 watt (w/3.3V)
K = 1100-1199 watt (w/3.3V)
L = 1200-1299 watt (w/3.3V)
M = 1300-1399 watt (w/3.3V)
N = 1400-1499 watt (w/3.3V)
X = Not installed

■ SHIELDING LEVEL

2 = Level 2
4 = MIL-STD-461
T = Tempest
X = Not installed

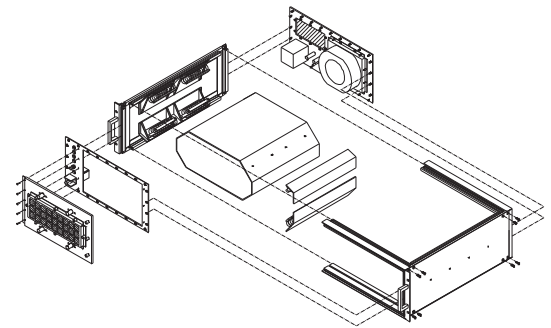

12R2 8U, Top Loaded



FEATURES

- VME, VME64x, VXS, VPX, cPCI or MicroTCA compatible
- 19" rackmount per IEC60297 (slide mounting optional), horizontal
- 8U H, standard depths: 22" and 25"
- 2-20 slot, IEEE 1101.10/.11 compliant card cages, top load
- Optional shock isolated cards cage and device mounting
- Front to rear evacuative cooling (350 LFM @ .1" H2O)
- Custom rear I/O patch panel
- MIL grade components
- Front mounted LEDs for; voltage monitoring, fan fail and over temp
- 500-1200 watt PSU options
- Input options: 90-264VAC Fixed PSU, 47-500 Hz, 28/48VDC

PRODUCT INFORMATION

The 8U, 12R2 is designed to meet the harsh environment of shipboard, airborne, and ground mobile applications per MIL-STD's. The top load card orientation optimizes space efficiency with superior cooling. Highly configurable, the unit can be ordered with choice of VME, VME64x, VXS, VPX, CPCI or MicroTCA, fixed or shock isolated card cage, device mounting, 500 to 1200 watt PSU, AC or DC input and custom I/O patch panel. Available in both 22" and 25" depths the unit holds up to 20, top loaded cards (fixed). Airflow is front to rear utilizing high volume fans. Shock isolated versions are designed to attenuate 25G shock inputs to the chassis to less than 10Gs at the card cage. All components, materials and design concepts are chosen to meet the applicable MIL-STD environments. The units come completely assembled and wired.

ORDERING INFORMATION

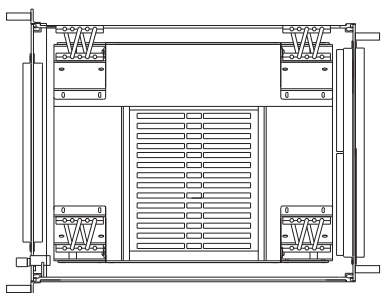

Description	Order Number
<ul style="list-style-type: none"> ■ 8U h x 22" d ■ Holds 14, 6U x 160mm cards, shock isolated, topload ■ Rear I/O patch panel ■ 12 slot VXS Dual Star backplane ■ No device mounting ■ 1200 watt, 90-264VAC PSU, 47-500 Hz ■ 2 x 235cfm, HV fan 	12R212LLXX88Y5TCL4

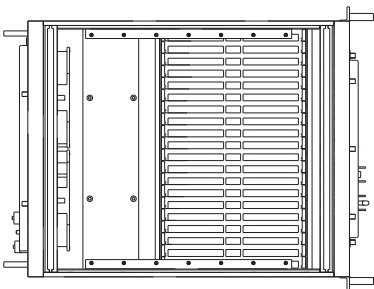

Description	Order Number
<ul style="list-style-type: none"> ■ 8U h x 22" d ■ Holds 20, 6U x 160mm cards, fixed mounted, top load ■ Rear I/O patch panel ■ 20 slot VME64x backplane w/P0 ■ No device mounting ■ 1000 watt, 90-264VAC PSU, 47-500 Hz ■ 2 x 235cfm, HV fan 	12R220OPXX88N5TCF4

LINE DRAWINGS

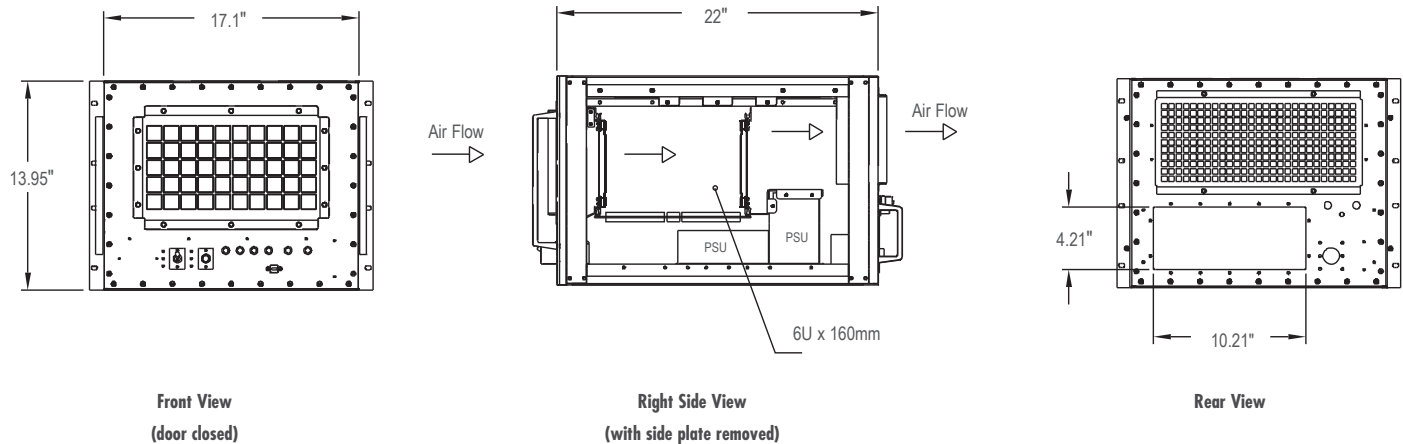

CUSTOM CONFIGURATIONS

1 2 R 2 ■ ■ ■ ■ ■ ■ 8 8 ■ ■ T ■ ■ ■

NUMBER OF SLOTS BP

00-20: Single BP AY-YA: Split

Example: 7 slot = 07

Example: 12 + 9 = LI

BP BARE BOARD

A = CPCI (RSS)

K = VITA 31.1

L = VXS (DS)

M = V64, J12 mono, 3 row

N = VME64X, 6U

O = VME64X, 7U

P = VPX, 6U (VITA 46)

S = VXS (SS)

T = VXS (Mesh)

X = No BP installed

Z = Custom

BP CONNECTOR CONFIG. J1/J2/P0

L = 5 row, w/o P0, w/ RT-2

M = 3 row, J1 flush, J2 13mm

N = 3 row, J1/J2, 17mm

O = 5 row, w/o P0

P = 5 row, w/ P0

Q = 3 row, 13mm

R = 3 row, 17mm

S = RT-2(J0-J6) 6U

D = CPCI (P1 & P2 S; P3, P4, P5 L)

X = No connectors

Z = Custom

DRIVES

1 = 1 X 3.5"

2 = 2 X 3.5"

3 = 1 X 5.25" HH

4 = 2 X 5.25" HH

5 = 4 X 5.25" HH

6 = 2 X 3.5", 1 X 5.25"HH

7 = 1 X 3.5", 2 X 5.25"HH

9 = 1 X 3.5", 1 X 5.25"HH

A = 1 x 2.5", 1 X CDROM (SL)

B = 2 x 2.5"

C = 6 x 5.25" HH

D = 1 x slim line CDROM

DEVICE MOUNTING

F = Fixed mount devices

I = Shock isolated devices

X = N/A

HEIGHT

8 = 8U

WIDTH

8 = 84T

CARD CAGE

Y = Fixed w/ Rear I/O

N = Fixed no Rear I/O

F = Isolated w/ Rear I/O

I = Isolated no Rear I/O

DEPTH

4 = 400mm - 499mm

5 = 500mm - 599mm (22")

6 = 600mm - 699mm (25")

7 = 700mm - 799mm

CARD ORIENTATION

T = Top Load

PSU INPUT

C = 90-230VAC (Fixed)

G = 90-230VAC (Plug In)

H = 48VDC (Plug In)

K = 48VDC (Fixed)

M = 48VDC (2 x HS, N+1)

N = 28VDC (Fixed)

O = 28VDC (2 x HS, N+1)

P = 90-230VAC(2 x HS, N+1)

Q = MIL-STD-704A, 28VDC

R = MIL-STD-704A, 90-230VAC

S = Custom

X = No PSU

PSU OUTPUT

(Note: Not all PSU combinations available)

3 = 300-399 watts (w/o 3.3V)

4 = 400-499 watts (w/o 3.3V)

5 = 500-599 watt (w/o 3.3V)

6 = 600-699 watt (w/o 3.3V)

7 = 700-799 watt (w/o 3.3V)

8 = 800-899 watt (w/o 3.3V)

9 = 900-999 watt (w/o 3.3V)

A = 100-199 watt (w/ 3.3V)

B = 200-299 watt (w/3.3V)

C = 300-399 watt (w/3.3V)

D = 400-499 watt (w/3.3V)

E = 500-599 watt (w/3.3V)

F = 600-699 watt (w/ 3.3V)

G = 700-799 watt (w/ 3.3V)

H = 800-899 watt (w/3.3V)

I = 900-999 watt (w/3.3V)

J = 1000-1099 watt (w/3.3V)

K = 1100-1199 watt (w/3.3V)

L = 1200-1299 watt (w/3.3V)

M = 1300-1399 watt (w/3.3V)

N = 1400-1499 watt (w/3.3V)

X = Not installed

SHIELDING LEVEL

2 = Level 2

4 = MIL-STD-461

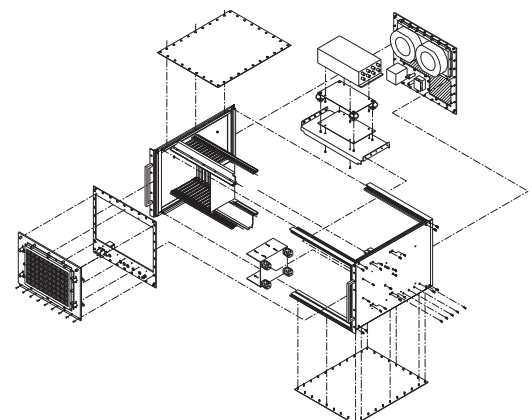

12R2 8U, Front Loaded



FEATURES

- VME, VME64x, VXS, VPX, cPCI or MicroTCA compatible
- 19" rackmount per IEC60297 (slide mounting optional)
- 8U H, standard depth 25"
- 2-20 slot, IEEE 1101.10/.11 compliant card cages, front load
- Optional device mounting
- Front to rear evacuative cooling (350 LFM @ .1" H20)
- Custom rear I/O patch panel
- Rear I/O cards
- MIL grade components
- Front mounted LEDs for; voltage monitoring, fan fail and over temp
- 500-1200 watt PSU options
- Input options: 90-264VAC Fixed PSU, 47-500 Hz, 28/48VDC

PRODUCT INFORMATION

The 8U, 12R2 is designed to meet the harsh environment of shipboard, airborne, and ground mobile applications per MIL-STD's. The front load card orientation optimizes space efficiency and serviceability. Highly configurable, the unit can be ordered with choice of VME, VME64x, VXS, VPX, CPCI or MicroTCA, rear I/O card mounting, device mounting, 500 to 1200 watt PSU, AC or DC input and custom I/O patch panel. Available in both 22" and 25" depths the unit holds up to 20, front loaded cards (fixed). Airflow is front to rear utilizing high volume fans. All components, materials and design concepts are chosen to meet the applicable MIL-STD environments. The units come completely assembled and wired.

ORDERING INFORMATION

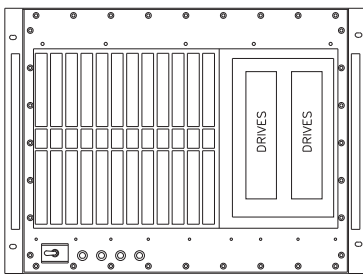

Description	Order Number
<ul style="list-style-type: none"> ■ 8U h x 25" d ■ Holds 12, 6U x 160mm cards, fixed mounted, front load ■ Holds 12, 6U x 80mm, rear I/O cards ■ 12 slot VME64x backplane, w/PO ■ Mounting for 2 x 5.25" devices ■ 500 watt, 90-264VAC PSU, 47-500 Hz ■ 2 x 235cfm, HV fan 	12R212OP5F88Y6VCC4

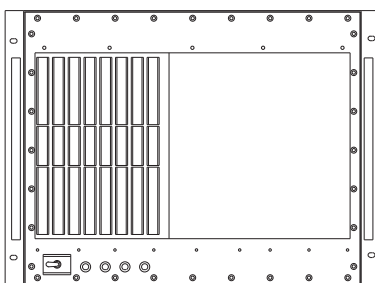

Description	Order Number
<ul style="list-style-type: none"> ■ 8U h x 25" d ■ Holds 8, 6U x 160mm cards, fixed mounted, front load ■ Holds 8, 6U x 80mm, rear I/O cards ■ 12 slot VXS Dual Star backplane ■ Mounting for 2 x 5.25" devices ■ 800 watt, 90-264VAC PSU, 47-500 Hz ■ 2 x 235cfm, HV fan 	12R212LL5F88X6VCH4

LINE DRAWINGS

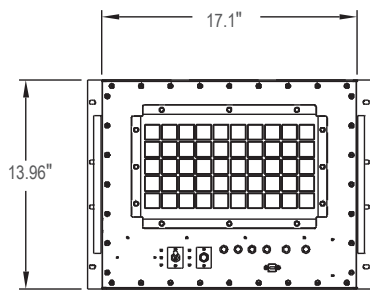

Front View
(door closed)

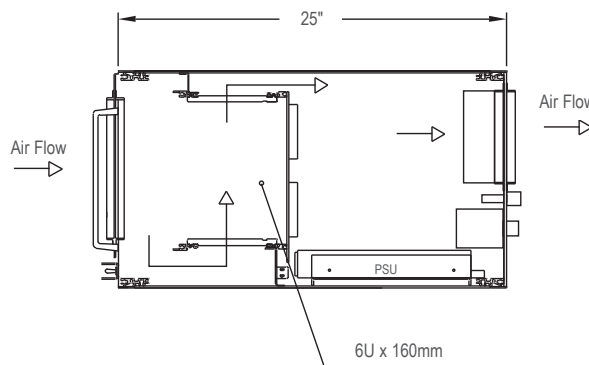

Right Side View
(with side plate removed)

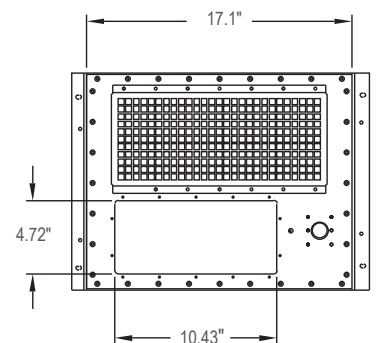

Rear View

CUSTOM CONFIGURATIONS

1 2 R 2 ■ ■ ■ ■ ■ ■ 8 8 ■ ■ V ■ ■

NUMBER OF SLOTS BP

00-20: Single BP AY-YA: Split
Example: 7 slot = 07
Example: 12 + 9 = LI

BP BARE BOARD

A = CPCI (RSS)
K = VITA 31.1
L = VXS (DS)
M = V64, J12 mono, 3 row
N = VME64X, 6U
O = VME64X, 7U
P = VPX, 6U (VITA 46)
S = VXS (SS)
T = VXS (Mesh)
X = No BP installed
Z = Custom

BP CONNECTOR CONFIG. J1/J2/P0

L = 5 row, w/o P0, w/ RT-2
M = 3 row, J1 flush, J2 13mm
N = 3 row, J1/J2, 17mm
O = 5 row, w/o P0
P = 5 row, w/ PO
Q = 3 row, 13mm
R = 3 row, 17mm
S = RT-2 (J0-J6) 6U
D = CPC I (P1 & P2 S; P3, P4, P5 L)
X = No connectors
Z = Custom

DRIVES

1 = 1 X 3.5"
2 = 2 X 3.5"
3 = 1 X 5.25" HH
4 = 2 X 5.25" HH
5 = 4 X 5.25" HH
6 = 2 X 3.5", 1 X 5.25" HH
7 = 1 X 3.5", 2 X 5.25" HH
9 = 1 X 3.5", 1 X 5.25" HH
A = 1 x 2.5", 1 X CDROM (SL)
B = 2 x 2.5"
C = 6 x 5.25" HH
D = 1 x slim line CDROM
X = Not installed

DEVICE MOUNTING

F = Fixed mount devices
I = Shock isolated devices
X = N/A

HEIGHT

8 = 8U

WIDTH

8 = 84T

CARD CAGE

Y = Fixed w/ Rear I/O
N = Fixed no Rear I/O
F = Isolated w/ Rear I/O
I = Isolated no Rear I/O

DEPTH

4 = 400mm - 499mm
5 = 500mm - 599mm (22")
6 = 600mm - 699mm (25")
7 = 700mm - 799mm

CARD ORIENTATION

V = Vertical

PSU INPUT

C = 90-230VAC (Fixed)
G = 90-230VAC (Plug In)
H = 48VDC (Plug In)
K = 48VDC (Fixed)
M = 48VDC (2 x HS, N+1)
N = 28VDC (Fixed)
O = 28VDC (2 x HS, N+1)
P = 90-230VAC(2 x HS, N+1)
Q = MIL-STD-704A, 28VDC
R = MIL-STD-704A, 90-230VAC
S = Custom
X = No PSU

PSU OUTPUT

(Note: Not all PSU combinations available)

3 = 300-399 watt (w/o 3.3V)
4 = 400-499 watt (w/o 3.3V)
5 = 500-599 watt (w/o 3.3V)
6 = 600-699 watt (w/o 3.3V)
7 = 700-799 watt (w/o 3.3V)
8 = 800-899 watt (w/o 3.3V)
9 = 900-999 watt (w/o 3.3V)
A = 100-199 watt (w/ 3.3V)
B = 200-299 watt (w/3.3V)
C = 300-399 watt (w/3.3V)
D = 400-499 watt (w/3.3V)
E = 500-599 watt (w/3.3V)
F = 600-699 watt (w/ 3.3V)
G = 700-799 watt (w/ 3.3V)
H = 800-899 watt (w/3.3V)
I = 900-999 watt (w/3.3V)
J = 1000-1099 watt (w/3.3V)
K = 1100-1199 watt (w/3.3V)
L = 1200-1299 watt (w/3.3V)
M = 1300-1399 watt (w/3.3V)
N = 1400-1499 watt (w/3.3V)
X = Not installed

SHIELDING LEVEL

2 = Level 2
4 = MIL-STD-461
T = Tempest

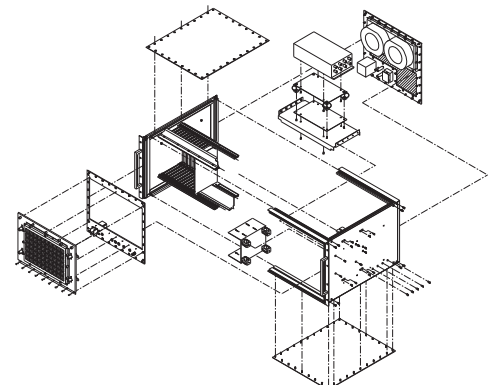

12R2 9U, Front Loaded

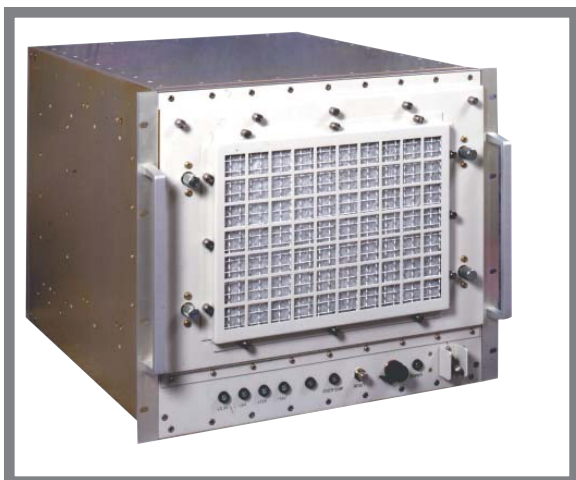

FEATURES

- VME, VME64x, VXS, VPX, cPCI or MicroTCA compatible
- 19" rackmount per IEC60297 (slide mounting optional)
- 9U H, standard depths 22" and 25"
- 2-20 slot, IEEE 1101.10/.11 compliant card cages, front load
- Optional device mounting
- Front to rear evacuative cooling (350 LFM @ .1" H2O)
- Custom rear I/O patch panel (rear I/O cards optional)
- MIL grade components
- Front mounted LEDs for; voltage monitoring, fan fail and over temp
- 500-1400 watt PSU options
- Input options: 90-264VAC Fixed PSU, 47-500 Hz, 28/48VDC

PRODUCT INFORMATION

The 9U, 12R2 is designed to meet the harsh environment of shipboard, airborne, and ground mobile applications per MIL-STD's. The front load card orientation optimizes space efficiency, serviceability and cooling. Highly configurable, the unit can be ordered with choice of VME, VME64x, VXS, VPX, CPCI or MicroTCA, fixed or shock isolated card cage, rear I/O card mounting, device mounting, 500 to 1200 watt PSU, AC or DC input and custom I/O patch panel. Available in both 22" and 25" depths the unit holds up to 20, front loaded cards (fixed). Airflow is front to rear utilizing high volume fans. Shock isolated versions are designed to attenuate 25G shock inputs to the chassis to less than 10Gs at the card cage. All components, materials and design concepts are chosen to meet the applicable MIL-STD environments. The units come completely assembled and wired.

ORDERING INFORMATION

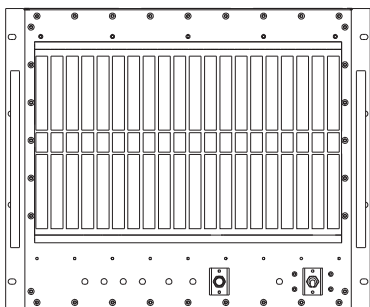

Description	Order Number
<ul style="list-style-type: none"> ■ 9U h x 22" d ■ Holds 20, 6U x 160mm cards, fixed mounted, front load ■ Rear I/O patch panel ■ 20 slot VME64x backplane w/P0 ■ No device mounting ■ 1000 watt, 90-264VAC PSU, 47-500 Hz ■ 2 x 235cfm, HV fan 	12R220OPXX98N5VCF4

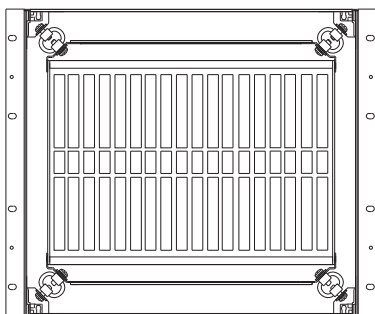

Description	Order Number
<ul style="list-style-type: none"> ■ 9U h x 22" d ■ Holds 14, 6U x 160mm cards, shock isolated, front load ■ Rear I/O patch panel ■ 18 slot VXS Dual Star backplane ■ No device mounting ■ 1200 watt, 90-264VAC PSU, 47-500 Hz ■ 2 x 325cfm, HV fan 	12R220LLXX98N5VCL4

LINE DRAWINGS

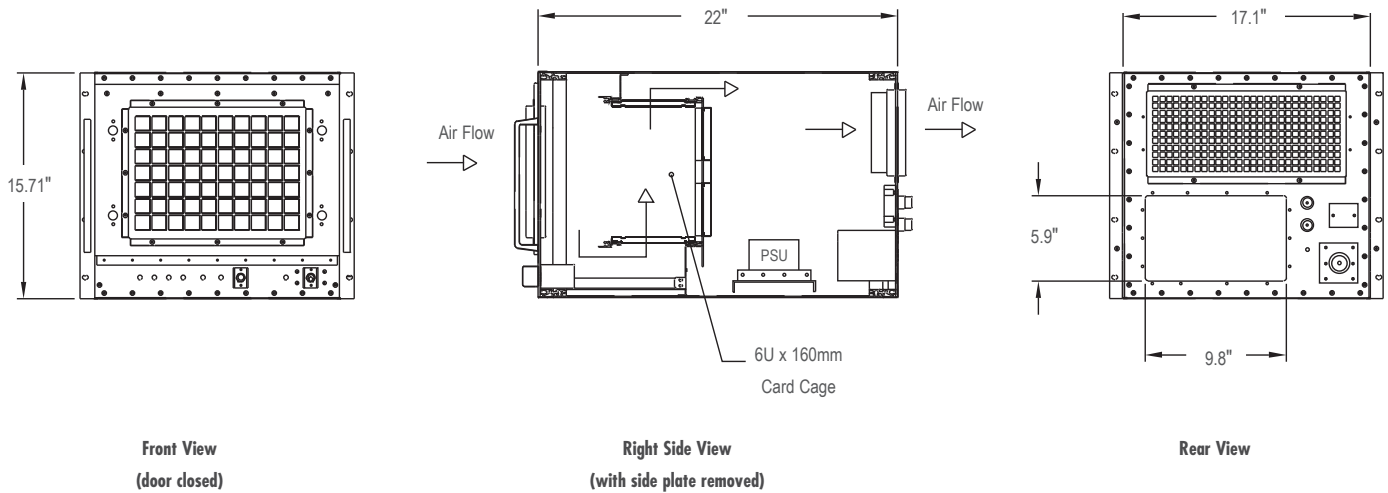

CUSTOM CONFIGURATIONS

1 2 R 2 ■ ■ ■ ■ ■ ■ 9 8 ■ ■ V ■ ■ ■

NUMBER OF SLOTS BP

00-20: Single BP AY-YA: Split
Example: 7 slot = 07
Example: 12 + 9 = LI

BP BARE BOARD

A = CPCI (RSS)
K = VITA 31.1
L = VXS (DS)
M = V64, J12 mono, 3 row
N = VME64X, 6U
O = VME64X, 7U
P = VPX, 6U (VITA 46)
S = VXS (SS)
T = VXS (Mesh)
X = No BP installed
Z = Custom

BP CONNECTOR CONFIG. J1/J2/P0

L = 5 row, w/o P0, w/ RT-2
M = 3 row, J1 flush, J2 13mm
N = 3 row, J1/J2, 17mm
O = 5 row, w/o P0
P = 5 row, w/ PO
Q = 3 row, 13mm
R = 3 row, 17mm
S = RT-2 (J0-J6) 6U
D = CPCI (P1 & P2 S; P3, P4, P5 L)
X = No connectors
Z = Custom

DRIVES

1 = 1 X 3.5"
2 = 2 X 3.5"
3 = 1 X 5.25" HH
4 = 2 X 5.25" HH
5 = 4 X 5.25" HH
6 = 2 X 3.5", 1 X 5.25"HH
7 = 1 X 3.5", 2 X 5.25"HH
9 = 1 X 3.5", 1 X 5.25"HH
A = 1 x 2.5", 1 X CDROM (SL)
B = 2 x 2.5"
C = 6 x 5.25" HH
D = 1 x slim line CDROM
X = Not installed

DEVICE MOUNTING

F = Fixed mount devices
I = Shock isolated devices
X = N/A

HEIGHT

9 = 9U

WIDTH

8 = 84T

CARD CAGE

Y = Fixed w/ Rear I/O
N = Fixed no Rear I/O
F = Isolated w/ Rear I/O
I = Isolated no Rear I/O

DEPTH

4 = 400mm - 499mm
5 = 500mm - 599mm (22")
6 = 600mm - 699mm (25")
7 = 700mm - 799mm

CARD ORIENTATION

V = Vertical

PSU INPUT

C = 90-230VAC (Fixed)
G = 90-230VAC (Plug In)
H = 48VDC (Plug In)
K = 48VDC (Fixed)
M = 48VDC (2 x HS, N+1)
N = 28VDC (Fixed)
O = 28VDC (2 x HS, N+1)
P = 90-230VAC (2 x HS, N+1)
Q = MIL-STD-704A, 28VDC
R = MIL-STD-704A, 90-230VAC
S = Custom
X = No PSU

PSU OUTPUT

(Note: Not all PSU combinations available)

3 = 300-399 watt (w/o 3.3V)
4 = 400-499 watt (w/o 3.3V)
5 = 500-599 watt (w/o 3.3V)
6 = 600-699 watt (w/o 3.3V)
7 = 700-799 watt (w/o 3.3V)
8 = 800-899 watt (w/o 3.3V)
9 = 900-999 watt (w/o 3.3V)
A = 100-199 watt (w/ 3.3V)
B = 200-299 watt (w/3.3V)
C = 300-399 watt (w/3.3V)
D = 400-499 watt (w/3.3V)
E = 500-599 watt (w/3.3V)
F = 600-699 watt (w/ 3.3V)
G = 700-799 watt (w/ 3.3V)
H = 800-899 watt (w/3.3V)
I = 900-999 watt (w/3.3V)
J = 1000-1099 watt (w/3.3V)
K = 1100-1199 watt (w/3.3V)
L = 1200-1299 watt (w/3.3V)
M = 1300-1399 watt (w/3.3V)
N = 1400-1499 watt (w/3.3V)
X = Not installed

SHIELDING LEVEL

2 = Level 2
4 = MIL-STD-461

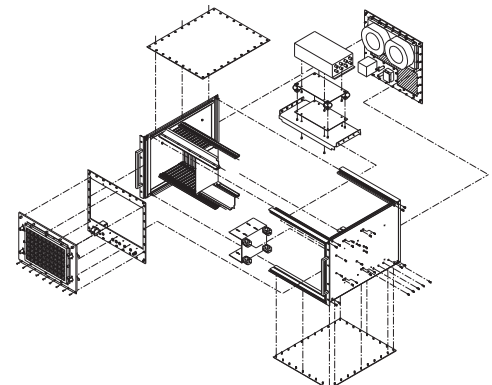

12R2 9U, Rugged PC



FEATURES

- ISA/PCI compatible
- 19" rackmount or bottom flush mount
- 9U H, standard depth 25"
- 4-20 slot ISA/PCI compliant cards, top load
- Mounting for 2 x 5.25"HH and 2 x 3.5" devices
- Front to rear evacuative cooling (350 LFM @ .1" H2O)
- Custom rear I/O patch panel (rear I/O cards optional)
- MIL grade components
- Front mounted LEDs for; voltage monitoring, fan fail and over temp
- 500-1200 watt PSU options
- Input options: 90-264VAC Fixed PSU, 47-500 Hz, 28/48VDC

PRODUCT INFORMATION

The 9U, 12R2 was designed to meet the harsh environment of shipboard, airborne, and ground mobile applications per MIL-STD's. This PC-based chassis provides a platform for COTS hardware to be used in a rugged environment. Highly configurable, the unit can be order with choice of ISA/PCI backplane or motherboard, fixed or shock isolated card cage, device mounting, 500 to 1200 watt PSU, AC or DC input and custom I/O patch panel. Available in both 25" depth the unit holds up to 20, top loaded cards (fixed). Airflow is front to rear utilizing high volume fans. Shock isolated versions are designed to attenuate 25G shock inputs to the chassis to less than 10Gs at the card cage. All components, materials and design concepts are chosen to meet the applicable MIL-STD environments. The units come completely assembled and wired.

ORDERING INFORMATION

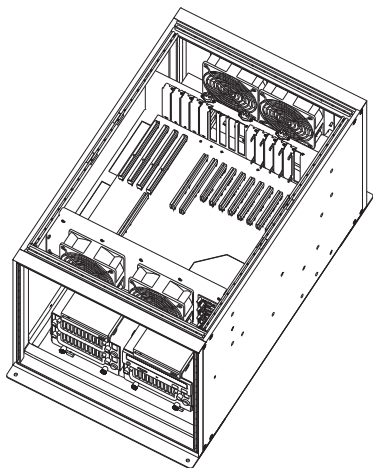

Description	Order Number
<ul style="list-style-type: none"> ■ 9U h x 25" d ■ Holds 15, ISA/PCI slots, top load ■ Rear I/O patch panel ■ 15 slot, 3 ISA/10PCI/2 dual backplane ■ Mounting for 2 x 5.25" HH and 2 x 3.5" devices ■ 1000 watt, 90-264VAC PSU, 47-500 Hz ■ 2 x 235cfm, HV fan 	<p>12R215GA8I98N6TCF4</p>

LINE DRAWINGS

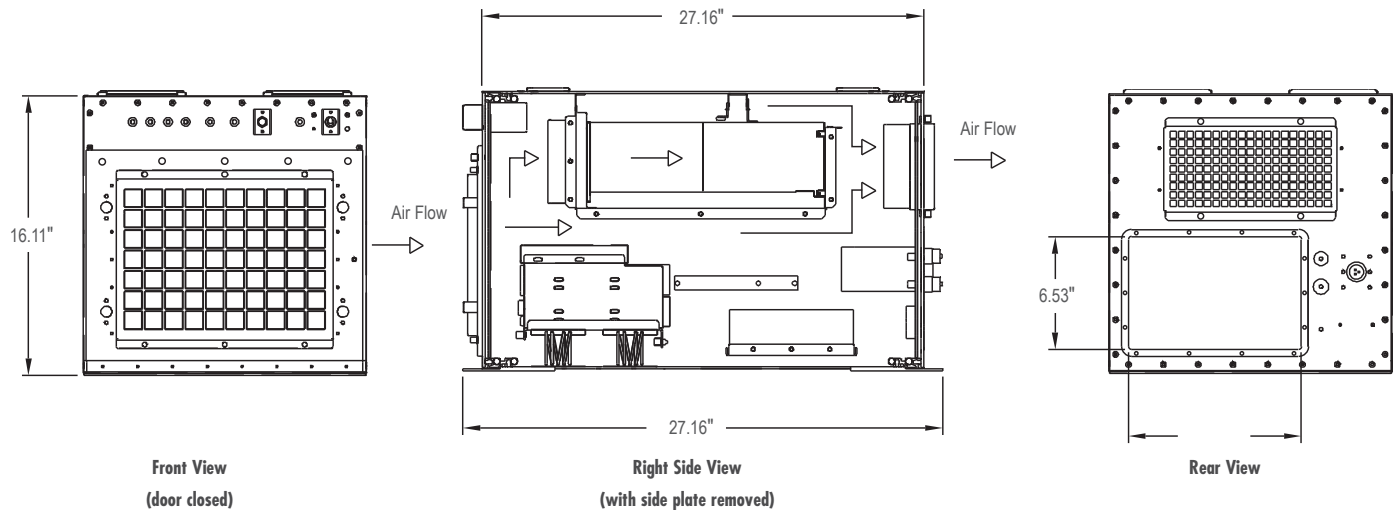

CUSTOM CONFIGURATIONS

1 2 R 2 ■ ■ ■ ■ ■ ■ ■ 8 ■ ■ T ■ ■ ■

■ NUMBER OF SLOTS BP

00-20: Single BP AY-YA: Split

Example: 7 slot = 07

Example: 12 + 9 = LI

■ BP BARE BOARD

G = PCI

H = Motherboard

X = No BP installed

Z = Custom

■ ISA/PCI

PCI Slots 0-9 A,B...

X = No Connectors

Z = Custom

■ DRIVES

1 = 1 x 3.5"

2 = 2 x 3.5"

3 = 1 x 5.25" HH

4 = 2 x 5.25" HH

6 = 2 x 3.5", 1 x 5.25" HH

7 = 1 x 3.5", 2 x 5.25" HH

8 = 2 x 3.5", 2 x 5.25" HH

9 = 1 x 3.5", 1 x 5.25" HH

A = 1 x 2.5", 1 x CDROM (SL)

B = 2 x 2.5"

D = 1 x slim line CDROM

X = Not installed

■ DEVICE MOUNTING

F = Fixed mount devices

I = Shock isolated devices

■ HEIGHT

9 = 9U

■ WIDTH

8 = 84T

■ CARD CAGE

Y = Fixed w/ Rear I/O

N = Fixed no Rear I/O

F = Isolated w/ Rear I/O

I = Isolated no Rear I/O

■ DEPTH

4 = 400mm - 499mm

5 = 500mm - 599mm (22")

6 = 600mm - 699mm (25")

7 = 700mm - 799mm

■ CARD ORIENTATION

T = Top Load

■ PSU INPUT

C = 90-230VAC (Fixed)

G = 90-230VAC (Plug In)

H = 48VDC (Plug In)

K = 48VDC (Fixed)

M = 48VDC (2 x HS, N+1)

N = 28VDC (Fixed)

O = 28VDC (2 x HS, N+1)

P = 90-230VAC(2 x HS, N+1)

Q = MIL-STD-704A, 28VDC

R = MIL-STD-704A, 90-230VAC

S = Custom

X = No PSU

■ PSU OUTPUT

(Note: Not all PSU combinations available)

3 = 300-399 watt (w/o 3.3V)

4 = 400-499 watt (w/o 3.3V)

5 = 500-599 watt (w/o 3.3V)

6 = 600-699 watt (w/o 3.3V)

7 = 700-799 watt (w/o 3.3V)

8 = 800-899 watt (w/o 3.3V)

9 = 900-999 watt (w/o 3.3V)

A = 100-199 watt (w/ 3.3V)

B = 200-299 watt (w/3.3V)

C = 300-399 watt (w/3.3V)

D = 400-499 watt (w/3.3V)

E = 500-599 watt (w/3.3V)

F = 600-699 watt (w/ 3.3V)

G = 700-799 watt (w/ 3.3V)

H = 800-899 watt (w/3.3V)

I = 900-999 watt (w/3.3V)

J = 1000-1099 watt (w/3.3V)

K = 1100-1199 watt (w/3.3V)

L = 1200-1299 watt (w/3.3V)

M = 1300-1399 watt (w/3.3V)

N = 1400-1499 watt (w/3.3V)

X = Not installed

■ SHIELDING LEVEL

2 = Level 2

4 = MIL-STD-461

T = Tempest

X = Not installed

12R2 10U, Front Loaded



FEATURES

- VME, VME64x, VXS, VPX, cPCI or MicroTCA compatible
- 19" rackmount per IEC60297 (slide mounting optional)
- 10U H, standard depth 22"
- 2-20 slot, IEEE 1101.10/.11 compliant card cages, front load
- Mounting for 2 x 5.25" HH and 1 x 3.5" devices
- Front to rear evacuative cooling (350 LFM @ .1" H2O)
- Custom rear I/O patch panel (rear I/O cards optional)
- MIL grade components
- Front mounted LEDs for; voltage monitoring, fan fail and over temp
- 500-1200 watt PSU options
- Input options: 90-264VAC Fixed PSU, 47-500 Hz, 28/48VDC

PRODUCT INFORMATION

The 10U, 12R2 was designed to meet the harsh environment of shipboard, airborne, and ground mobile applications per MIL-STD's. The front load card orientation combined with addition height maximizes slot count and device mounting capability. Highly configurable, the unit can be ordered with choice of VME, VME64x, VXS, VPX, CPCI or MicroTCA, fixed or shock isolated card cage, rear I/O card mounting, device mounting, 500 to 1200 watt PSU, AC or DC input and custom I/O patch panel. Available in both 22" and 25" depths the unit holds up to 20, front loaded cards (fixed). Airflow is front to rear utilizing high volume fans. Shock isolated versions are designed to attenuate 25G shock inputs to the chassis to less than 10Gs at the card cage. All components, materials and design concepts are chosen to meet the applicable MIL-STD environments. The units come completely assembled and wired.

ORDERING INFORMATION

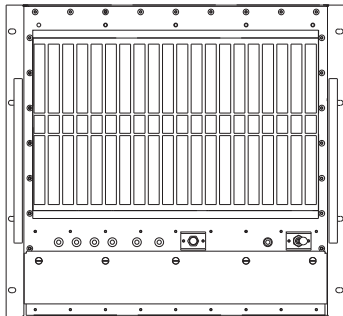

Description	Order Number
<ul style="list-style-type: none"> ■ 10U h x 22" d ■ Holds 20, 6U x 160mm cards, fixed mounted, front load ■ Rear I/O patch panel ■ 20 slot VME64x backplane w/P0 ■ Mounting for 2 x 5.25" HH and 1 x 3.5" devices ■ 1000 watt, 90-264VAC PSU, 47-500 Hz ■ 2 x 235cfm, HV fan 	12R220OP7F98Y6VCJ4

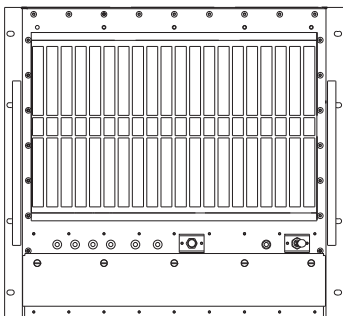

Description	Order Number
<ul style="list-style-type: none"> ■ 10U h x 22" d ■ Holds 20, 6U x 160mm cards, fixed mounted, front load ■ Rear I/O patch panel ■ 20 slot VXS Dual Star backplane ■ Mounting for 2 x 5.25" HH and 1 x 3.5" devices ■ 1200 watt@115 VAC, 1500 watt@220 VAC ■ 2 x 235cfm, HV fan 	12R220LL7F98Y6VCL4

LINE DRAWINGS

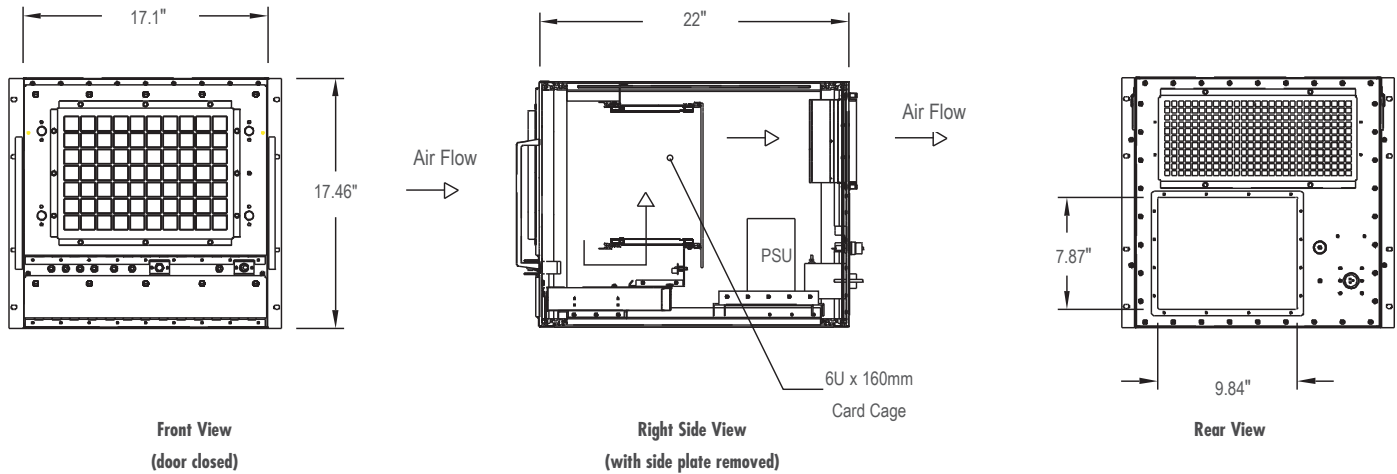

CUSTOM CONFIGURATIONS

1 2 R 2 ■ ■ ■ ■ ■ ■ A 8 ■ ■ V ■ ■ ■

NUMBER OF SLOTS BP

00-20: Single BP AY-YA: Split
 Example: 7 slot = 07
 Example: 12 + 9 = LI

BP BARE BOARD

A = CPCI (RSS), 6U
 K = VITA 31.1
 L = VXS (DS)
 M = V64, J12 mono, 3 row
 N = VME64X, 6U
 O = VME64X, 7U
 P = VPX, 6U (VITA 46)
 S = VXS (SS)
 T = VXS (Mesh)
 X = No BP installed
 Z = Custom

BP CONNECTOR CONFIG. J1/J2/P0

L = 5 row, w/o P0, w/ RT-2
 M = 3 row, J1 flush, J2 13mm
 N = 3 row, J1/J2, 17mm
 O = 5 row, w/o P0
 P = 5 row, w/ PO
 Q = 3 row, 13mm
 R = 3 row, 17mm
 S = RT-2 (J0-J6) 6U
 D = CPCI (P1 & P2 S; P3, P4, P5 L)
 X = No connectors
 Z = Custom

DRIVES

1 = 1 X 3.5"
 2 = 2 X 3.5"
 3 = 1 X 5.25" HH
 4 = 2 X 5.25" HH
 5 = 4 X 5.25" HH
 6 = 2 X 3.5", 1 X 5.25" HH
 7 = 1 X 3.5", 2 X 5.25" HH
 8 = 2 X 3.5", 2 X 5.25" HH
 9 = 1 X 3.5", 1 X 5.25" HH
 A = 1 x 2.5", 1 X CDROM (SL)
 B = 2 x 2.5"
 C = 6 x 5.25" HH
 D = 1 x slim line CDROM
 X = Not installed

DEVICE MOUNTING

F = Fixed mount devices
 I = Shock isolated devices
 X = N/A

HEIGHT

A = 10U

WIDTH

8 = 84T

CARD CAGE

Y = Fixed w/ Rear I/O
 N = Fixed no Rear I/O
 F = Isolated w/ Rear I/O
 I = Isolated no Rear I/O

DEPTH

4 = 400mm - 499mm
 5 = 500mm - 599mm (22")
 6 = 600mm - 699mm (25")
 7 = 700mm - 799mm

CARD ORIENTATION

V = Vertical

PSU INPUT

C = 90-230VAC (Fixed)
 G = 90-230VAC (Plug In)
 H = 48VDC (Plug In)
 K = 48VDC (Fixed)
 M = 48VDC (2 x HS, N+1)
 N = 28VDC (Fixed)
 O = 28VDC (2 x HS, N+1)
 P = 90-230VAC (2 x HS, N+1)
 Q = MIL-STD-704A, 28VDC
 R = MIL-STD-704A, 90-230VAC
 S = Custom
 X = No PSU

PSU OUTPUT

(Note: Not all PSU combinations available)

1 = 100-199 watt (w/o 3.3V)
 2 = 200-299 watt (w/o 3.3V)
 3 = 300-399 watt (w/o 3.3V)
 4 = 400-499 watt (w/o 3.3V)
 5 = 500-599 watt (w/o 3.3V)
 6 = 600-699 watt (w/o 3.3V)
 7 = 700-799 watt (w/o 3.3V)
 8 = 800-899 watt (w/o 3.3V)
 9 = 900-999 watt (w/o 3.3V)
 A = 100-199 watt (w/ 3.3V)
 B = 200-299 watt (w/3.3V)
 C = 300-399 watt (w/3.3V)
 D = 400-499 watt (w/3.3V)
 E = 500-599 watt (w/3.3V)
 F = 600-699 watt (w/ 3.3V)
 G = 700-799 watt (w/ 3.3V)
 H = 800-899 watt (w/3.3V)
 I = 900-999 watt (w/3.3V)
 J = 1000-1099 watt (w/3.3V)
 K = 1100-1199 watt (w/3.3V)
 L = 1200-1299 watt (w/3.3V)
 M = 1300-1399 watt (w/3.3V)
 N = 1400-1499 watt (w/3.3V)
 X = Not installed

SHIELDING LEVEL

2 = Level 2
 4 = MIL-STD-461
 T = Tempest
 X = Not installed

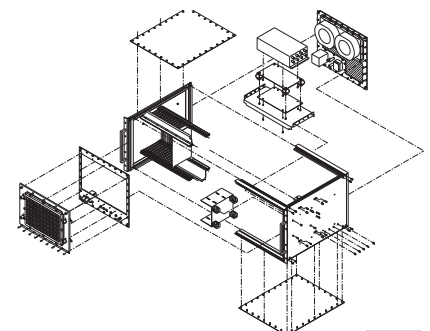

12R2 12U, Front Loaded



FEATURES

- Custom Card (9U), VME, VME64x, VXS, VPX, cPCI or MicroTCA compatible
- 19" rackmount per IEC60297 (slide mounting optional)
- 12U H, standard depths 22" and 25"
- 2-20 slot, IEEE 1101.10/.11 compliant card cages, front load
- Mounting for 4 x 5.25"HH devices
- Front to rear evacuative cooling (350 LFM @ .1" H20)
- Custom rear I/O patch panel (rear I/O cards optional)
- MIL grade components
- Front mounted LEDs for; voltage monitoring, fan fail and over temp
- 500-1200 watt PSU options
- Input options: 90-264VAC Fixed PSU, 47-500 Hz, 28/48VDC

PRODUCT INFORMATION

The 12U, 12R2 was designed to meet the harsh environment of shipboard, airborne, and ground mobile applications per MIL-STD's. The ability to mount 9U x 400mm or 6U x 160mm cards and a wide of array of device mounting options makes this unit an ideal platform for custom system design. Highly configurable, the unit can be order with choice of VME, VME64x, VXS, VPX, CPCI or MicroTCA, fixed or shock isolated card cage, rear I/O card mounting, device mounting, 500 to 1200 watt PSU, AC or DC input and custom I/O patch panel. Available in both 22" and 25" depths the unit holds up to 20, front loaded cards (fixed). Airflow is front to rear utilizing high volume fans. Shock isolated versions are designed to attenuate 25G shock inputs to the chassis to less than 10Gs at the card cage. All components, materials and design concepts are chosen to meet the applicable MIL-STD environments. The units come completely assembled and wired.

ORDERING INFORMATION

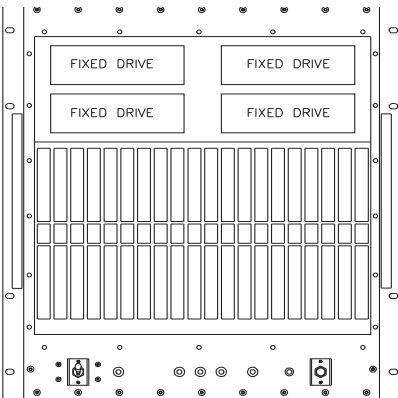

Description	Order Number
<ul style="list-style-type: none"> ■ 12U h x 25" d ■ Holds 20, 6U x 160mm cards, fixed mounted, front load ■ Holds 20, 6U x 80mm, rear I/O cards ■ 20 slot VME64x backplane w/P0 ■ Mounting for 4 x 5.25" HH devices ■ 1000 watt, 90-264VAC PSU, 47-500 Hz ■ 2 x 235cfm, HV fan 	12R2200P5FC8Y6VCF4

LINE DRAWINGS

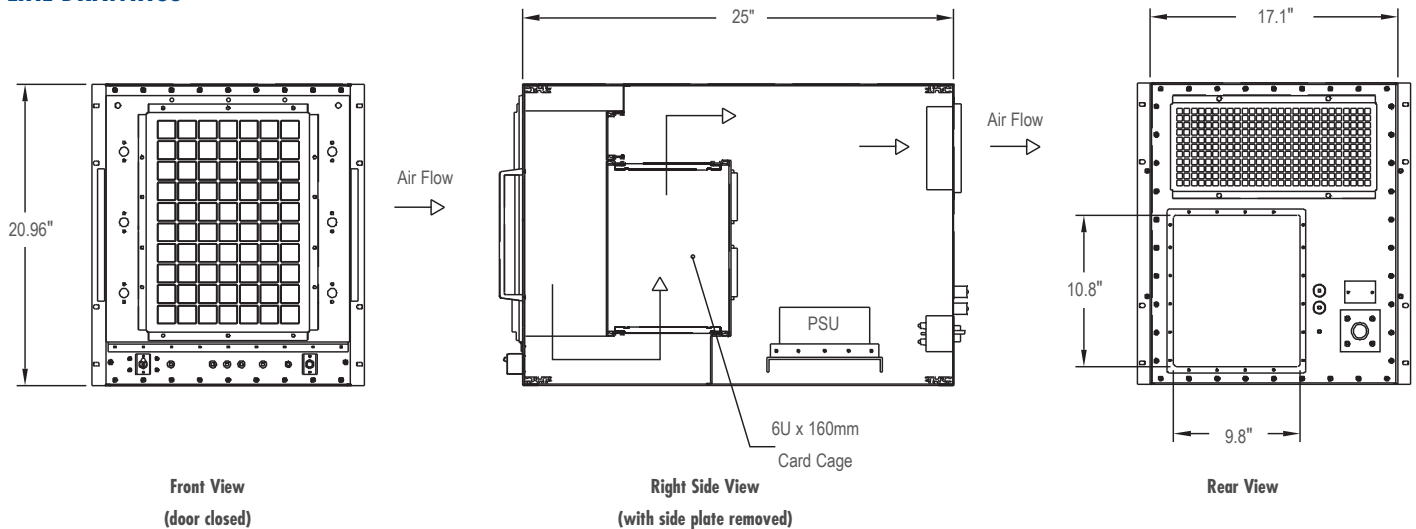

CUSTOM CONFIGURATIONS

1 2 R 2 ■ ■ ■ ■ ■ ■ ■ 8 ■ ■ ■ ■ ■

■ NUMBER OF SLOTS BP

00-20: Single BP AY-YA: Split
Example: 7 slot = 07
Example: 12 + 9 = LI

■ BP BARE BOARD

A = CPCI (RSS), 6U
K = VITA 31.1
L = VXS (DS)
M = V64, J12 mono, 3 row
N = VME64X, 6U
O = VME64X, 7U
P = VPX, 6U (VITA 46)
S = VXS (SS)
T = VXS (Mesh)
X = No BP installed
Z = Custom

■ BP CONNECTOR CONFIG. J1/J2/P0

L = 5 row, w/o P0, w/ RT-2
M = 3 row, J1 flush, J2 13mm
N = 3 row, J1/J2, 17mm
O = 5 row, w/o PO
P = 5 row, w/ PO
Q = 3 row, 13mm
R = 3 row, 17mm
S = RT-2 (J0-J6) 6U
D = CPCI (P1 & P2 S; P3, P4, P5 L)
X = No connectors
Z = Custom

■ DRIVES

1 = 1 X 3.5"
2 = 2 X 3.5"
3 = 1 X 5.25" HH
4 = 2 X 5.25" HH
5 = 4 X 5.25" HH
6 = 2 X 3.5", 1 X 5.25"HH
7 = 1 X 3.5", 2 X 5.25"HH
9 = 1 X 3.5", 1 X 5.25"HH
A = 1 x 2.5", 1 X CDROM (SL)
B = 2 x 2.5"
C = 6 x 5.25" HH
D = 1 x slim line CDROM
X = Not installed

■ DEVICE MOUNTING

F = Fixed mount devices
I = Shock isolated devices
X = N/A

■ HEIGHT

9 = 9U

■ WIDTH

8 = 84T

■ CARD CAGE

Y = Fixed w/ Rear I/O
N = Fixed no Rear I/O
F = Isolated w/ Rear I/O
I = Isolated no Rear I/O

■ DEPTH

4 = 400mm - 499mm
5 = 500mm - 599mm (22")
6 = 600mm - 699mm (25")
7 = 700mm - 799mm

■ CARD ORIENTATION

V = Vertical

■ PSU INPUT

C = 90-230VAC (Fixed)
G = 90-230VAC (Plug In)
H = 48VDC (Plug In)
K = 48VDC (Fixed)
M = 48VDC (2 x HS, N+1)
N = 28VDC (Fixed)
O = 28VDC (2 x HS, N+1)
P = 90-230VAC(2 x HS, N+1)
Q = MIL-STD-704A, 28VDC
R = MIL-STD-704A, 90-230VAC
S = Custom
X = No PSU

■ PSU OUTPUT

(Note: Not all PSU combinations available)

3 = 300-399 watt (w/o 3.3V)
5 = 500-599 watt (w/o 3.3V)
7 = 700-799 watt (w/o 3.3V)
8 = 800-899 watt (w/o 3.3V)
9 = 900-999 watt (w/o 3.3V)
A = 100-199 watt (w/ 3.3V)
B = 200-299 watt (w/3.3V)
C = 300-399 watt (w/3.3V)
D = 400-499 watt (w/3.3V)
E = 500-599 watt (w/3.3V)
F = 600-699 watt (w/ 3.3V)
G = 700-799 watt (w/ 3.3V)
H = 800-899 watt (w/3.3V)
I = 900-999 watt (w/3.3V)
J = 1000-1099 watt (w/3.3V)
K = 1100-1199 watt (w/3.3V)
L = 1200-1299 watt (w/3.3V)
M = 1300-1399 watt (w/3.3V)
N = 1400-1499 watt (w/3.3V)
X = Not installed

■ SHIELDING LEVEL

2 = Level 2
4 = MIL-STD-461
T = Tempest
X = Not installed

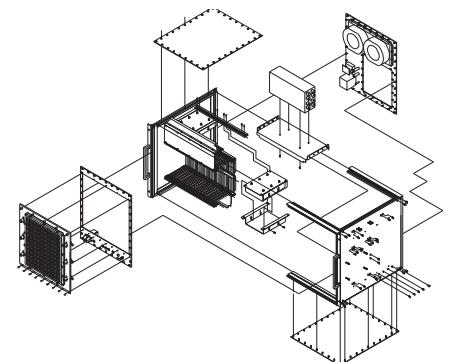

12R2 14U, Front Loaded

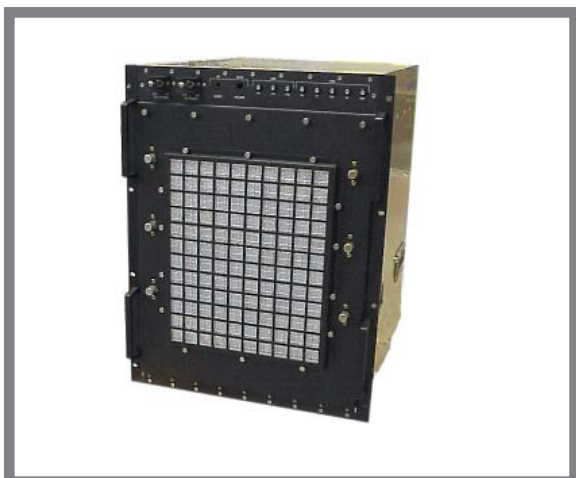

FEATURES

- VME, VME64x, VXS, VPX, cPCI or MicroTCA compatible
- 19" rackmount per IEC60297 (slide mounting optional)
- 14U H, standard depth 25"
- 2-20 slot, IEEE 1101.10/.11 compliant card cages, front load
- Front to rear evacuative cooling (350 LFM @ .1" H20)
- Custom rear I/O patch panel (rear I/O cards optional)
- MIL grade components
- Front mounted LEDs for; voltage monitoring, fan fail and over temp
- 500-2000 watt PSU options
- Plug removable shock isolated power supply tray
- Input options: 90-264VAC, 47-500 Hz, 28/48VDC

PRODUCT INFORMATION

The 14U, 12R2 was designed to meet the harsh environment of shipboard, airborne, and ground mobile applications per MIL-STD's. The standard front load card cage combined with the shock isolated PSU tray highlights the flexibility of the 12R2 packaging system. Highly configurable, the unit can be ordered with choice of VME, VME64x, VXS, VPX, CPCI or MicroTCA backplane, fixed or shock isolated card cage, rear I/O card mounting, device mounting, 500 to 1200 watt PSU, AC or DC input and custom I/O patch panel. Available in 25" depth the unit holds up to 20, front loaded cards (fixed). Airflow is front to rear utilizing high volume fans. Shock isolated versions are designed to attenuate 25G shock inputs to the chassis to less than 10Gs at the card cage and PSU tray. All components, materials and design concepts are chosen to meet the applicable MIL-STD environments. The units come completely assembled and wired.

ORDERING INFORMATION

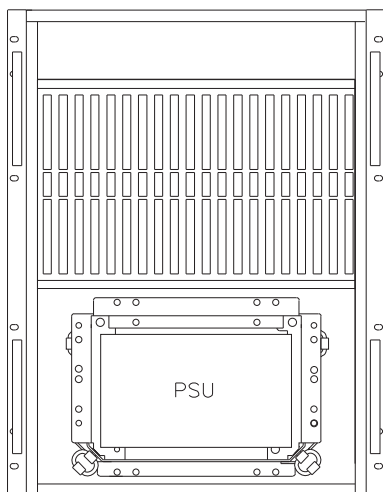

Description	Order Number
<ul style="list-style-type: none"> ■ 14U h x 25" d ■ Holds 20, 6U x 160mm cards, fixed mounted, front load ■ Rear I/O patch panel ■ 20 slot VME64x backplane w/P0 ■ No device mounting ■ Configurable, shock isolated, plug removable, PSU tray ■ 2 x 235cfm, HV fan 	12R2200PXXE8N5VCS4

LINE DRAWINGS

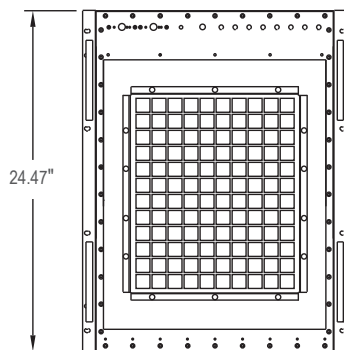

Front View
(door closed)

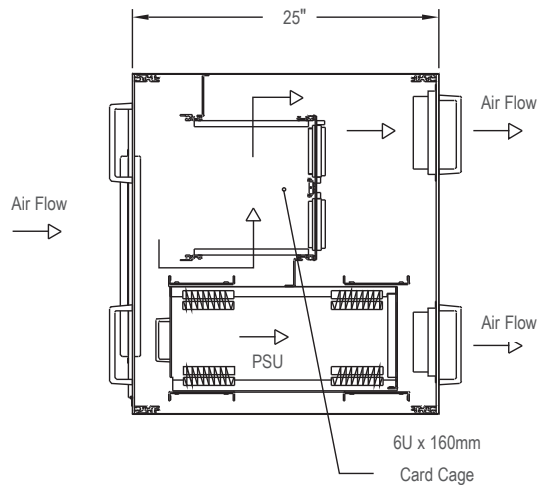

Right Side View
(with side plate removed)

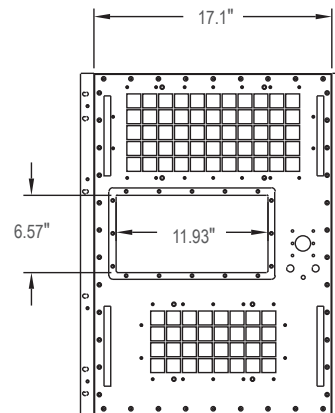

Rear View

CUSTOM CONFIGURATIONS

1 2 R 2 ■ ■ ■ ■ ■ ■ E 8 ■ ■ V ■ ■ ■

■ NUMBER OF SLOTS BP

00-20: Single BP AY-YA: Split

Example: 7 slot = 07

Example: 12 + 9 = LI

■ BP BARE BOARD

A = CPCI (RSS), 6U

K = VITA 31.1

L = VXS (DS)

M = V64, J12 mono, 3 row

N = VME64X, 6U

O = VME64X, 7U

P = VPX, 6U (VITA 46)

S = VXS (SS)

T = VXS (Mesh)

X = No BP installed

Z = Custom

■ BP CONNECTOR CONFIG. J1/J2/P0

L = 5 row, w/o P0, w/ RT-2

M = 3 row, J1 flush, J2 13mm

N = 3 row, J1/J2, 17mm

O = 5 row, w/o P0

P = 5 row, w/ P0

Q = 3 row, 13mm

R = 3 row, 17mm

S = RT-2(J0-J6) 6U

D = CPCI (P1 & P2 S; P3, P4, P5 L)

X = No connectors

Z = Custom

■ DRIVES

1 = 1 X 3.5"

2 = 2 X 3.5"

3 = 1 X 5.25" HH

4 = 2 X 5.25" HH

5 = 4 X 5.25" HH

6 = 2 X 3.5", 1 X 5.25"HH

7 = 1 X 3.5", 2 X 5.25"HH

8 = 2 X 3.5", 2 X 5.25"HH

9 = 1 X 3.5", 1 X 5.25"HH

A = 1 x 2.5", 1 X CDROM (SL)

B = 2 x 2.5"

C = 6 x 5.25" HH

D = 1 x slim line CDROM

X = Not installed

■ DEVICE MOUNTING

F = Fixed mount devices

I = Shock isolated devices

X = N/A

■ HEIGHT

E = 14U

■ WIDTH

8 = 84T

■ CARD CAGE

Y = Fixed w/ Rear I/O

N = Fixed no Rear I/O

F = Isolated w/ Rear I/O

I = Isolated no Rear I/O

■ DEPTH

4 = 400mm - 499mm

5 = 500mm - 599mm (22")

6 = 600mm - 699mm (25")

7 = 700mm - 799mm

■ CARD ORIENTATION

V = Vertical

■ PSU INPUT

C = 90-230VAC (Fixed)

G = 90-230VAC (Plug In)

H = 48VDC (Plug In)

K = 48VDC (Fixed)

M = 48VDC (2 x HS, N+1)

N = 28VDC (Fixed)

O = 28VDC (2 x HS, N+1)

P = 90-230VAC(2 x HS, N+1)

Q = MIL-STD-704A, 28VDC

R = MIL-STD-704A, 90-230VAC

S = Custom

X = No PSU

■ PSU OUTPUT

(Note: Not all PSU combinations available)

3 = 300-399 watt (w/o 3.3V)

4 = 400-499 watt (w/o 3.3V)

5 = 500-599 watt (w/o 3.3V)

6 = 600-699 watt (w/o 3.3V)

7 = 700-799 watt (w/o 3.3V)

8 = 800-899 watt (w/o 3.3V)

9 = 900-999 watt (w/o 3.3V)

A = 100-199 watt (w/ 3.3V)

B = 200-299 watt (w/3.3V)

C = 300-399 watt (w/3.3V)

D = 400-499 watt (w/3.3V)

E = 500-599 watt (w/3.3V)

F = 600-699 watt (w/ 3.3V)

G = 700-799 watt (w/ 3.3V)

H = 800-899 watt (w/3.3V)

I = 900-999 watt (w/3.3V)

J = 1000-1099 watt (w/3.3V)

K = 1100-1199 watt (w/3.3V)

L = 1200-1299 watt (w/3.3V)

M = 1300-1399 watt (w/3.3V)

N = 1400-1499 watt (w/3.3V)

X = Not installed

■ SHIELDING LEVEL

2 = Level 2

4 = MIL-STD-461



T = Tempest

X = Not installed

12R2 Order Key

1 2 R 2               

PRODUCT CODE **SLOTS** **BP BARE BOARD** **BP CONNECTORS** **DRIVES** **DEVICE MOUNTING** **HEIGHT** **WIDTH** **CARD CAGE** **DEPTH** **CARD ORIENTATION** **PSU INPUT** **PSU OUTPUT** **SHIELDING**

  NUMBER OF SLOTS BP
00-20: Single BP AY-YA: Split
Example: 7 slot = 07
Example: 12 + 9 = LI

 BP BARE BOARD
A = CPCI (RSS), 6U
K = VITA 31.1
L = VXS (DS)
M = V64, J12 mono, 3 row
N = VME64X, 6U
O = VME64X, 7U
P = VPX, 6U (VITA 46)
W = VPX, 3U (VITA 46)
S = VXS (SS)
T = VXS (Mesh)
U = CPCI Express, 3U
X = No BP installed
Z = Custom

 BP CONNECTOR CONFIG. J1/J2/P0
L = 5 row, w/o P0, w/ RT-2
M = 3 row, J1 flush, J2 13mm
N = 3 row, J1/J2, 17mm
O = 5 row, w/o PO
P = 5 row, w/ PO
Q = 3 row, 13mm
R = 3 row, 17mm
S = RT-2 (J0-J6) 6U
U = RT-2 (J0-J2) 3U
D = CPCI (P1 & P2 S; P3, P4, P5 L)
X = No connectors
Z = Custom

 DRIVES
1 = 1 X 3.5"
2 = 2 X 3.5"
3 = 1 X 5.25" HH
4 = 2 X 5.25" HH
5 = 4 X 5.25" HH
6 = 2 X 3.5", 1 X 5.25"HH
7 = 1 X 3.5", 2 X 5.25"HH
8 = 2 X 3.5", 2 X 5.25"HH
9 = 1 X 3.5", 1 X 5.25"HH
A = 1 x 2.5", 1 X CDROM (SL)

B = 2 x 2.5"
C = 6 x 5.25" HH
D = 1 x slim line CDROM
X = Not installed
8 = 2 x 3.5", 2 x 5.25" HH
9 = 1 x 3.5", 1 x 5.25" HH
A = 1 x 2.5", 1 x CDROM (SL)
B = 2 x 2.5"
C = 6 x 5.25" HH
X = Not installed

 DEVICE MOUNTING
F = Fixed mount devices
I = Shock isolated devices

 HEIGHT
5 = 5U
6 = 6U
7 = 7U
8 = 8U
A = 10U

 WIDTH
8 = 84T

 CARD CAGE
Y = Fixed w/Rear I/O
N = Fixed no Rear I/O
F = Isolated w/Rear I/O
I = Isolated no Rear I/O

 DEPTH
4 = 400mm - 499mm
5 = 500mm - 599mm (22")
6 = 600mm - 699mm (25")
7 = 700mm - 799mm

 CARD ORIENTATION
V = Vertical
H = Horizontal
T = Top Load

 PSU INPUT
C = 90-230VAC (Fixed)
G = 90-230VAC (Plug In)
H = 48VDC (Plug In)
K = 48VDC (Fixed)
M = 48VDC (2 x HS, N+1)
N = 28VDC (Fixed)
O = 28VDC (2 x HS, N+1)
P = 90-230VAC (2 x HS, N+1)
Q = MIL-STD-704A, 28VDC
R = MIL-STD-704A, 90-230VAC
S = Custom
X = No PSU

 PSU OUTPUT
(Note: Not all PSU combinations available)
1 = 100-199 (w/o 3.3V)
2 = 200-299 watts (w/o 3.3V)
3 = 300-399 watts (w/o 3.3V)
4 = 400-499 watts (w/o 3.3V)
5 = 500-599 watt (w/o 3.3V)
6 = 600-699 watt (w/o 3.3V)
7 = 700-799 watt (w/o 3.3V)
8 = 800-899 watt (w/o 3.3V)
9 = 900-999 watt (w/o 3.3V)
A = 100-199 watt (w/ 3.3V)
B = 200-299 watt (w/3.3V)
C = 300-399 watt (w/3.3V)
D = 400-499 watt (w/3.3V)
E = 500-599 watt (w/3.3V)
F = 600-699 watt (w/ 3.3V)
G = 700-799 watt (w/ 3.3V)
H = 800-899 watt (w/3.3V)
I = 900-999 watt (w/3.3V)
J = 1000-1099 watt (w/3.3V)
K = 1100-1199 watt (w/3.3V)
L = 1200-1299 watt (w/3.3V)
M = 1300-1399 watt (w/3.3V)
N = 1400-1499 watt (w/3.3V)
X = Not installed

 SHIELDING LEVEL
2 = Level 2
4 = MIL-STD-461
T = Tempest
X = Not installed

12RC Rugged COTS Chassis - Conduction Cooled

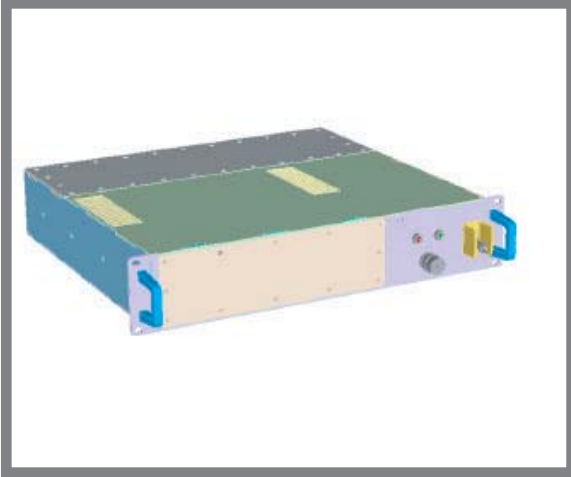

FEATURES

- VME, VME64x, VXS, VPX, cPCI or MicroTCA compatible
- 19" rackmount, depths from 16" to 20"
- 2U to 4U heights
- According to IEEE 1101.2
- Backplane in 2 - 8 slots
- Horizontal card mounting
- Wide range of PSU options
- Optional configurable I/O patch panel on rear
- Optional slide rail mounting
- Ready to run - turnkey solutions
- Custom configurations available

PRODUCT INFORMATION

Elma's conduction cooled 12RC platforms provide the highest level of environmental protection with exceptional thermal performance. The heat load is transferred via wedge locks from the boards to the machined platform walls with the integrated card guides. The 12RCs accept all 3U and 6U boards complying with IEEE 1101.2. The cooling concept of all conduction cooled ATRs is optimized by thermal analysis. The chassis parts are made from special grade aluminum and joined by a dip-brazing process to ensure the best conductivity of heat load. All removable covers are equipped with captive screws.

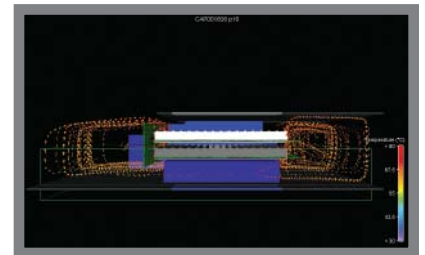
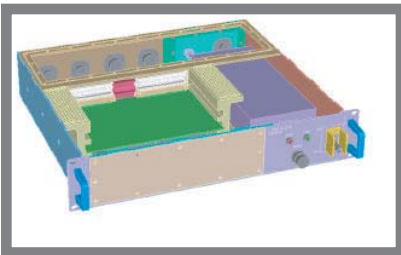

ATR (Air Transport Rack)



PRODUCT OVERVIEW

Continuing to innovate in the manufacturing of ruggedized, modular, COTS systems platforms, Elma's full line of convection and conduction cooled ATR (Air Transport Rack) enclosures offer a standardized, cost effective solution for VME, VME64x, VXS, MicroTCA, cPCI and cPCI Express based applications. Available in 1/2, 3/4, 1 and 1 1/2 ATR tall long or tall short formats per ARINC 404A, ARINC 600 and IEEE 1101.10 specifications, the modular design concept allows for a wide range of customization options without the cost and lead time penalties associated with custom designs.

The all-aluminum ATRs are made from punched and formed sheet metal and milled plates. A removable front panel allows I/O customization to exact application requirements and increased configurability. The ATR enclosures use electrostatic dust filters, honeycomb EMI filters and a narrow screw spacing to seal off every external seam to ensure compliance to MIL-STD-461D. The rugged designs meet the requirement for shock, vibration and structural integrity per MIL-STD-810F, MIL-STD-167 and MIL-STD-901D.

In addition to the full range of available case sizes, standard options include: 5-15 slot 6U x 160mm card cages, 150-750 watt power supplies, 28VDC or 90-230VAC (440 Hz) input, up to 470 CFM cooling systems and configurable I/O. All Elma Electronic Inc, system platforms come fully assembled and wired offering a "turnkey" packaging solution.

Elma's ATR products incorporates Mil-grade components like Mil-38999 connector, integrated sensors, line filters, on/off and reset switches, LEDs, fuses, breakers, etc. Fan options include the use of full Mil-grade high altitude fan tray can operate under extremely harsh temperature conditions. Depending on applications specific equipments either commercial, industrial or Mil-grade power supplies can be used.

MIL-STD

- MIL-STD-5400: General standard for Aerospace Electronic Equipment
- MIL-STD-810F: Environmental Test Methods and Engineering Guidelines
- MIL-STD-461E: Requirements for the control of EMI Emissions and Susceptibility
- MIL-STD-704E: Aircraft Electric Power Characteristics
- MIL-STD-1275A: Characteristics of 28 Volt DC Electrical Systems in Military Vehicles

APPLICATION EXAMPLES

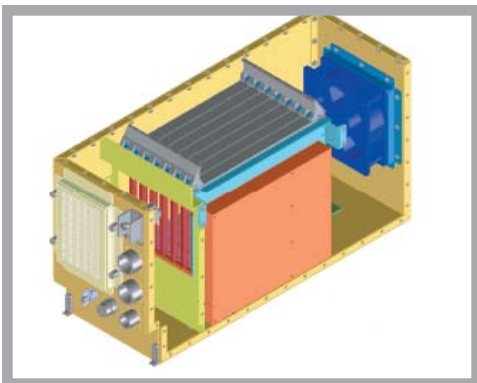

ATR PRODUCT SELECTION

ATR ORDER NUMBER	ATRATL05...	ATRBTS07...	ATRBTL07...	ATRCTL12...	ATRDTL15...
Size	1/2 ATR Tall, Long	3/4 ATR Tall, Short	3/4 ATR Tall, Long	1 ATR Tall, Long	1 1/2 ATR Tall, Long
Slots	4	7	11	12	15
Backplane	VME,VME64x,cPCI	VME,VME64x,cPCI	VME,VME64x,cPCI	VME,VME64x,cPCI	VME,VME64x,cPCI
Width	123.95mm (4.9")	190.5mm (7.5")	190.5mm (7.5")	257.05mm(10.12")	390.65mm (15.38)
Height	269.88mm (10.625")	269.88mm (10.625")	269.88mm (10.625")	269.88mm (10.625")	269.88mm (10.625")
Depth	498mm (19.6")	320.5mm (12.62")	498mm (19.6")	498mm (19.6")	498mm (19.6")
Power Supply	250 watts 5V@30A 3.3V@30A +12V@4A -12V@4A	350 watts 5V@30A 3.3V@30A +12V@8A -12V@8A	350 watts 5V@30A 3.3V@30A +12V@8A -12V@8A	500 watts 5V@60A 3.3V@30A +12V@8A -12V@8A	700 watts 5V@80A 3.3V@60A +12V@8A -12V@8A
Weight (without boards)	17lbs.	22 lbs.	25lbs.	33 lbs.	45 lbs.

STANDARD ATR CASE DIMENSIONS

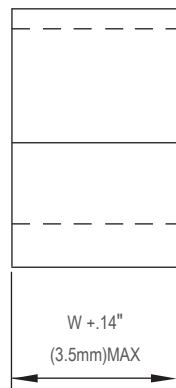

Front View

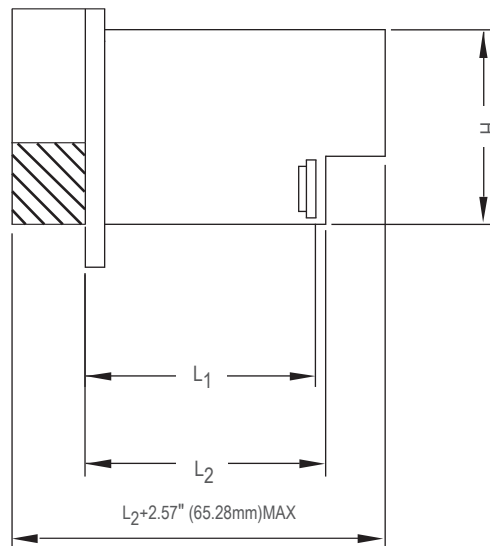

Side View

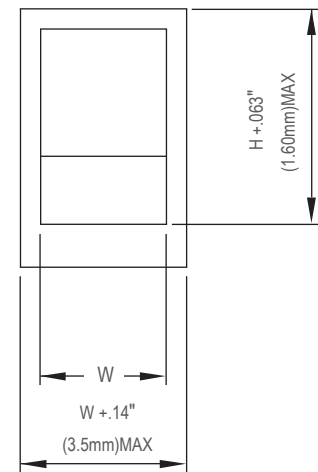

Top View

ATR Size	Approx. Volume		Width(W)		Length(L1)		Length (L2)		Height (H)	
	in ³	liter ³	±.03in	±0.76mm	±.04in	±1mm	in	mm	in	mm
1/2 Short	470	7.70	4.88	123.95	12.52	318.0	12.62	320.5	10.625	269.88
1/2 Long	725	11.88	4.88	123.95	19.52	495.8	19.62	498.3	10.625	269.88
3/4 Short	720	11.80	7.50	190.50	12.52	318.0	12.62	320.5	10.625	269.88
3/4 Long	1120	18.36	7.50	190.50	19.52	495.8	19.52	498.3	10.625	269.88
1 Short	975	15.98	10.12	257.05	12.52	318.0	12.62	320.5	10.625	269.88
1 Long	1510	24.75	10.12	257.05	19.52	495.8	19.62	498.3	10.625	269.88
1 1/2 Long	2295	37.62	15.38	390.65	19.52	495.8	19.62	498.3	10.625	269.88

Notes: Per ARINC characteristic 561 INS, the standard dimension 'H' = 7.62" may be increased to a maximum 'H' dimension of 10.625" (269.88mm) when necessary for equipment reasons.

ATR PRODUCT OVERVIEW

POWER SUPPLY FEATURES

- Low Noise FM Control
- Military Specification Compliance
(MIL-STD-461C: EMI/RFI, MIL-STD704A, 1275A: Transients & Spikes, MIL-I-45208: Quality System)

Parameter	Min.	Typ.	Max.	Units	Notes
Input Characteristics					
28 VDC Input Modules:					
Steady State Input	18	28	50	VDC	20ms,50W per MIL-STD704A 100ms,15mJ per MIL-STD1275A
Input Spike Limit	-600		+600	VDC	
	-250		+250	VDC	
Input Surge Limit:			100	VDC	60ms,0.5Wper MIL-STD1275A
Overvoltage Shutdown		50			100ms Automatic Recovery
Inrush Current		110	125	%IIN	Steady state IIN 10ms
EMI/RFI Characteristics; (MIL-STD-461D, Class A1b)					
Input Power Leads:					
Conducted Emissions	CE03				MIL-STD-461D
Conducted Susceptibility	CS02				MIL-STD-461D
Radiated Susceptibility	RS03				
Output Characteristics					
Load/Line Regulation		0.2%	0.5%	VNOM	LL to HL, NL to 10%
		0.05%	0.2%	VNOM	LL to HL, 10% to FL
Thermal Characteristics					
Efficiency		77	81	%	

FAN FEATURES

- High performance axial fan
- Feathered edge for lower noise
- High reliability ball bearings
- Range: 80 - 350 CFM
- Operating temperature: -10°C to +70°C
- Per MIL-STD-461D meets EMI standards per FCC Part 15, Subpart J of Docket 20780, Class A & B radiated and conducted emissions, meets EMI standards per VDE Spec. 0871/6.78 for cat. A&B requirements
- Isolated tachometer output-square wave output equal to two pulses per revolution

ENVIRONMENTAL SPECIFICATIONS

PARAMETER	I GRADE	M GRADE	APPLICABLE SPECIFICATION
Temp, Operating	-10° to +55°C	-55 ° to +85°C	MIL-STD-810F (Methods 501.3 & 502.3)
Temp, non-Operating	-30° to +85°C	-55 ° to +85°C	MIL-STD-810F (Methods 501.3 & 502.3)
Shock	15 g 11ms	25g 11ms	MIL-STD-810F (Method 516.4)
Vibration	15 to 2,000 Hz at .1g2/Hz (RMS – 12G)	15 to 2,000 Hz at .1g2/Hz (RMS – 12G)	MIL-STD-810F (Method 514.4)
Altitude, Operating	15,000 ft	55,000 ft	MIL-STD-810F (Method 500.3)
Humidity	0-95% non-condensing	0-95% non-condensing	MIL-STD-810F (Method 507.3)
Salt fog	Limited	Conformal Coating 5% for 48 hours	MIL-STD-810F (Method 509.3)
Wiring	Limited Toxicity	Limited Toxicity	MIL-C-24643
EMC	MIL-STD-461D	Tempest	MIL-STD-461D Tempest

ATR Products



3/4 ATR PLATFORM, TALL/LONG

- Backplane in VME/64x, cPCI, VXS, VPX or MicroTCA up to 7 slots
- Vertical card mounting (top loading) 6U x 160mm
- Up to 400 watts of power with 28VDC or optional AC input
- Bottom patch panel offers access to P2 section of the backplane
- Integral cooling with front-to-rear airflow
- Mil-grade high-performance Ametek Rotron fan, capable of providing over 15 CFM per slot at altitudes over 35000 feet and operating temperature of 55°C to 85°C
- Integral cooling with front-to-rear airflow
- **Order Number: ATR7507V645XP28VDC**



1 ATR PLATFORM, TALL/LONG

- Vertical card mounting (top loading) 6U x 160mm VME64x compliant
- Backplane in VME/64x, cPCI, VPX, VXS, or MicroTCA, up to 8 slots
- Standard 28 VDC Power Supply, 400 W
- Measures 10.12" w x 10.62" h x 19.6" d
- P2 and P0 backplane backside connector pins required
- Minimum 2.0 inches required below the backplane (2.5 inches preferred)
- Bottom patch panel offers access to P2 section of the backplane
- Integral cooling with front-to-rear airflow
- Indicator/I-O front panel
- DC input connector, power on/off toggle switch, elapsed time meter and voltage indicators with voltage monitor
- Front-mounted carrying handles and mounting hooks
- Fan fail indicator and reset switch (optional)
- **Order Number: ATRCTL100PNXVTNZ46U**



1 1/2 ATR PLATFORM, TALL/LONG

- Backplane in VME/64x, cPCI, VPX, VXS or MicroTCA in sizes up to 15 slots
- Vertical card mounting (top loading) 6U x 160mm
- Power Supply: 120 VAC or 28 VDC
- Measures 15.38" w x 12" h x 19.6" d
- P2 and P0 backplane backside connector pins
- Bottom patch panel offers access to P2 section of the backplane
- Integral cooling with front-to-rear airflow
- AC input connector, power on/off toggle switch, elapsed time meter and voltage indicators with voltage monitor, status indicator I-O front panel
- Front-mounted carrying handles and mounting hooks
- Fan fail indicator and reset switch (optional)

ATR Products - Conduction Cooled

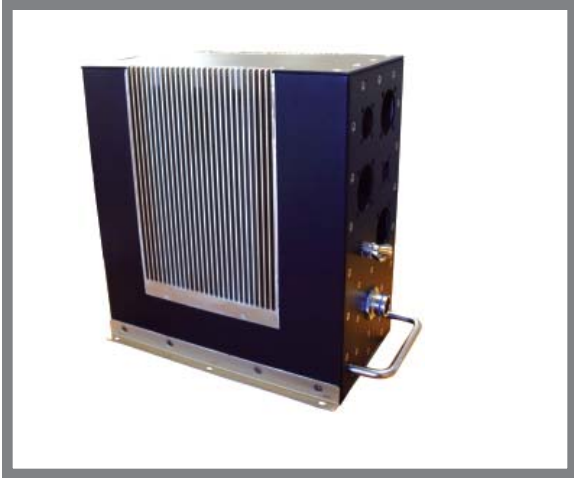

FEATURES

- Meets ARINC 404A, ARINC600 and IEEE 1101.2 specifications
- Operating temperature range of -40°C to +70°C
- Low weight, ideal for applications where the weight is critical
- Backplane options for VME/64X, cPCI, VX5, VPX, MicroTCA and custom
- Features a MIL 38999 type power connector with an integrated line filter
- Power supply and line filter combination are optimized to meet MIL-STD 461E
- Rugged aluminum dip-braised construction is designed to meet MIL-STD 810F for shock and vibration
- Optimized for cooling via thermal simulation studies

PRODUCT INFORMATION

Elma's conduction cooled ATR platforms provide the highest level of environmental protection with exceptional thermal performance. The heat load is transferred via wedge locks from the boards to the machined platform walls with the integrated card guides. The ATRs accept all 3U and 6U boards complying with IEEE 1101.2. The cooling concept of all conduction cooled ATRs is optimized by thermal analysis. The chassis parts are made from special grade aluminum and joined by a dip-braising process to ensure the best conductivity of heat load. All removable covers are equipped with captive screws.

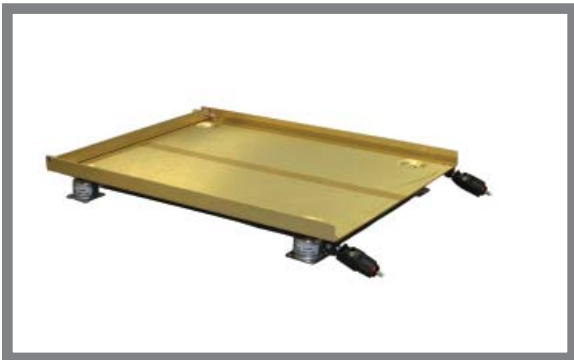
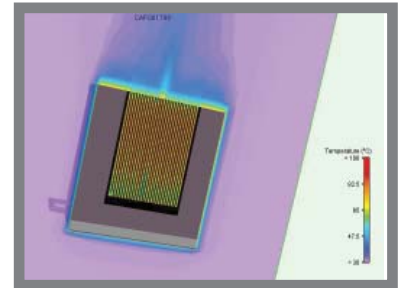
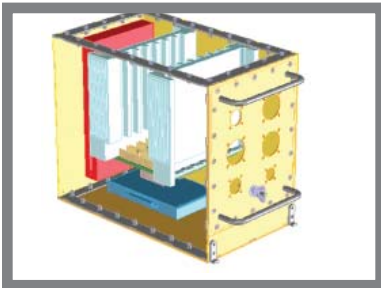

ATR TRAY

- Meets ARINC 404A specification
- Sized for a short and long ATRs
- Guide pins allow ease for blind-mating insertion
- Tray is shock isolated via four mounting points

ORDERING INFORMATION

Size	Part Number
1/2 short	TATR-AS-S
3/4 short	TATR-BS-S
3/4 long	TATR-BL-S
1 long	TATR-CL-S
1 1/2 long	TATR-DL-S

ATR Order Key

A T R



PRODUCT
CODE

WIDTH

HEIGHT

DEPTH

SLOTS

BARE BOARD

BP CONNECTORS

DRIVES

MOUNTING

COOLING

CARD ORIENTATION

PSU INPUT

PSU OUTPUT

SHIELDING

WIDTH

A = ½ (123.95mm)
B = ¾ (190.5mm)
C = 1 (257.05mm)
D = 1 ½ (390.65mm)

HEIGHT

T = Tall (269.88mm)
Z = Custom

DEPTH

L = Long (498.3mm)
S = Short (320.5mm)

NUMBER OF SLOTS BP

00-20: Single BP AY-YA: Split
Example: 7 slot = 07
Example: 12 + 9 = LI

BP BARE BOARD

A = CPCI (RSS), 6U
K = VITA 31.1
L = VXS (DS)
M = V64, J12 mono, 3 row
N = VME64X, 6U
O = VME64X, 7U
P = VPX, 6U (VITA 46)
W = VPX, 3U (VITA 46)
S = VXS (SS)
T = VXS (Mesh)
U = CPCI Express, 3U
X = No BP installed
Z = Custom

BP CONNECTOR CONFIG: J1/J2/P0

L = 5 row, w/o P0, w/ RT-2
M = 3 row, J1 flush, J2 13mm
N = 3 row, J1/J2, 17mm
O = 5 row, w/o PO
P = 5 row, w/ PO
Q = 3 row, 13mm
R = 3 row, 17mm
S = RT-2 (J0-J6) 6U
U = RT-2 (J0-J2) 3U
D = CPCI (P1 & P2 S; P3, P4, P5 L)
X = No connectors
Z = Custom

DRIVES

Y = Yes
N = No

DEVICE MOUNTING

F = Fixed mount devices
I = Shock isolated devices

COOLING

C = Conduction
H = Conduction/Convection
L = Liquid
V = Convection
T = Top Load

CARD ORIENTATION

V = Vertical
H = Horizontal
T = Top Load

PSU INPUT

C = 90-230VAC (47-500Hz)
N = 28VDC (Fixed)
Q = MIL-STD-704A, 28VDC
R = MIL-STD-704A, 90-230VAC (47-500Hz)
S = Custom
X = No PSU

PSU OUTPUT

(Note: Not all PSU combinations available)

1 = 100-199 (w/o 3.3V)
2 = 200-299 watt (w/o 3.3V)
3 = 300-399 watt (w/o 3.3V)
4 = 400-499 watt (w/o 3.3V)
5 = 500-599 watt (w/o 3.3V)
6 = 600-699 watt (w/o 3.3V)
7 = 700-799 watt (w/o 3.3V)
8 = 800-899 watt (w/o 3.3V)
9 = 900-999 watt (w/o 3.3V)
A = 100-199 watt (w/ 3.3V)
B = 200-299 watt (w/3.3V)
C = 300-399 watt (w/3.3V)
D = 400-499 watt (w/3.3V)
E = 500-599 watt (w/3.3V)
F = 600-699 watt (w/ 3.3V)
G = 700-799 watt (w/ 3.3V)
H = 800-899 watt (w/3.3V)
I = 900-999 watt (w/3.3V)
J = 1000-1099 watt (w/3.3V)
K = 1100-1199 watt (w/3.3V)
L = 1200-1299 watt (w/3.3V)
M = 1300-1399 watt (w/3.3V)
N = 1400-1499 watt (w/3.3V)
4 = MIL-STD-461
X = Not installed
X = Not installed

Shielding Level

4 = MIL-STD-461
X = Not installed

Backplanes

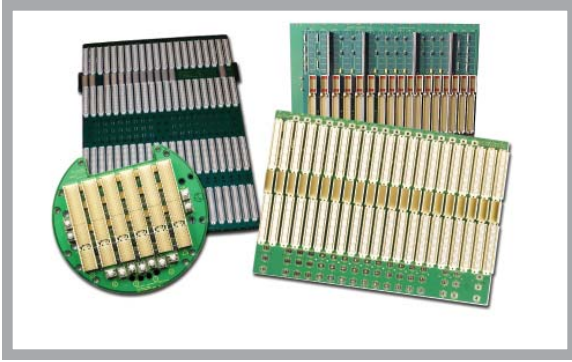

FEATURES

- Available in VME, VME64x, cPCI, cPCI Express, AdvancedTCA, MicroTCA, VXS, VPX, and VXI architectures
- 2 to 21 slot versions available
- Customization available
- Optional backplane stiffeners
- Conformal coating available
- Optional MIL-grade components
- Simulation services

All Elma backplanes are designed to maximize performance, minimize noise, and to give the customer the most reliable, cost-effective product possible. To achieve this we use controlled impedance, stripline design, decoupling capacitors at every slot, inboard terminators, heavy power and ground planes, transient analysis simulation programs, and years of experience designing, building, and using backplanes. Three 2 oz. copper ground layers are used to fully shield the backplane to minimize RF/EMI emission/susceptibility, to minimize crosstalk, and to maximize power distribution.

Elma specializes in custom backplanes to meet your exact specifications. Backplane simulation/characterization services are available.

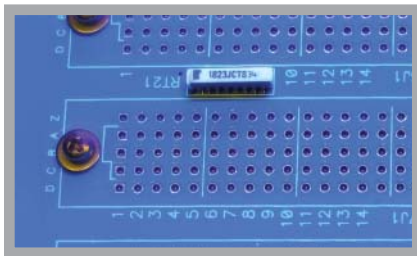

Conformal Coating - under blue light

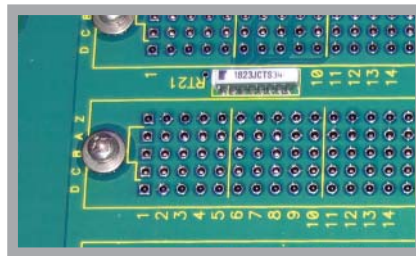

Conformal Coating - regular view

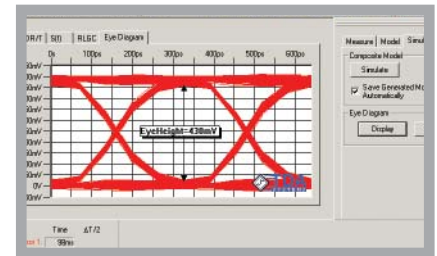

Signal Integrity - eye diagram

DESIGN AND ENGINEERING

Elma's backplane division, Elma Bustronic has a design and engineering team that is among the best in the business and has constantly delivered innovative and intelligent solutions. The company has been the recognized leader in high-performance MIL/COTS designs. Our leadership and expertise in VME, VME64x, VXS, VPX, VXI, CompactPCI, AdvancedTCA, MicroTCA and CompactPCI Express backplanes keeps us on the cutting edge of technology. With over 2000 custom designs under our belt, Elma Bustronic can find a solution to almost any requirement you may have. Our signal integrity services include backplane characterization and pre-design simulation and model extraction.

PRODUCTION CAPABILITIES

The Elma Bustronic SMT line is over 40' long and includes an in-line printer, a pick-and-place SMT assembly machine, re-flow soldering system, and a multi-solvent backplane cleaning machine. Our customers benefit with faster turnaround times, increased volume and board complexity capabilities, and higher precision quality.

For special projects, we are able to use our automated assembly line in Germany. Over 40 meters long, the line includes SMT assembly, vapor phase soldering, press fit capability, electrical, and optical testing. The Automated Assembly Line can support PCB sizes of up to 31.50" x 23.62" and thickness of up to 0.315". The SMT machines can assemble up to 10,000 components/hr with .03 mm precision. The Pressfit Assembly portion of the line has a cycle time of 3-5 seconds with 0.2 mm precision. Electrical and Optical testing can be performed including up to 21,620 electrical test points and a speed of 1000 measurements per second.

Accessories



Dimensions

Height: 106.8mm/4.2"
Thickness: 10mm/0.400" (With Rear Bracket)
Thickness: 6.5mm/0.26" (Moving Parts)

Rugged Slide Rail Size 5

Length with rear bracket 580-800mm (22.8" - 31.5")
Slide travel 565mm (22.2")
Order Number CAE016383



Dimensions

Height: 65mm/2.56"
Thickness: 7.5mm/0.3"
Thickness: 5.8mm/0.23" (Moving Parts)

AUTOMATIC RELEASE IN EXTENDED POSITION

Slide Rail Size 3

Length with rear bracket 463-682mm (18.2" - 26.8")
Slide travel 511mm (20.1")
Order Number 65-051

Slide Rail Size 5

Length with rear bracket 565-783mm (22.2" - 30.8")
Slide travel 596mm (23.5")
Order Number 65-052

Slide Rail Size 7

Length with rear bracket 666-885mm (26.2" - 34.8")
Slide travel 726mm (28.3")
Order Number 65-053

RUGGED SLIDE RAILS

- Securely locked in extended position
- Quick front disconnect
- Rugged rear bracket
- 19" flanges with closed holes
- Roller assisted movement
- Made from cold rolled steel, zinc plated
- Load max. size 5 (static) 1000N (220lbs)
- Load max. size 7 (static) 800N (175lbs)

Rugged Slide Rail Size 7

Length with rear bracket 680mm-900mm (26.8"-35.4")
Slide travel 765mm (30.1")
Order Number CAE016384

STANDARD SLIDE RAILS

- Securely locked in extended position or automatic release in extended position
- Quick front disconnect
- Rear bracket
- 19" flanges with open holes
- Made from cold rolled steel
- Low friction, high-abrasive paint for corrosion-protection
- Load max. (static) 600N (130lbs)

SECURELY LOCKED IN EXTENDED POSITION

Slide Rail Size 3

Length with rear bracket 463-682mm (18.2" - 26.8")
Slide travel 511mm (20.1")
Order Number CAE014621

Slide Rail Size 5

Length with rear bracket 565-783mm (22.2" - 30.8")
Slide travel 596mm (23.5")
Order Number CAE010393

Slide Rail Size 7

Length with rear bracket 666-885mm (26.2" - 34.8")
Slide travel 726mm (28.3")
Order Number CAE011080

Accessories

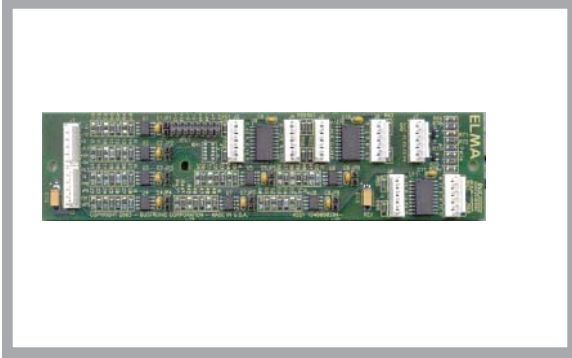

VOLTAGE MONITOR

- Ability to directly drive up to 12 LEDs (bi-color or single color)
- Monitors up to 8 voltages (4 positive and 4 negative)
- Preset for all "standard" VXI, VME, and cPCI backplane voltages (+5V, -5.2V, +/-12V, +3.3V, +/-24V, -2.0V)
- Series and parallel pads on voltage monitors for easy changing of scaling resistors
- Ability to "OR" the outputs of several voltage indicators to drive a single LED
- Four optional LED drivers for indicating the status of fans, temp sensors, etc.
- Separate power sources for voltage monitors and optional LED drivers
- Sold only as part of overall chassis solution

Board Specifications

2-layer design
2 oz. copper power and ground
PCB .062" thick
PCB UL recognized 94V-0
PCB FR-4 or equivalent

Mechanical Specifications

7" x 1.5"
Nine 6-pin Molex headers
(22-11-2062)

The new Voltage monitor is designed to provide fast, "go/no-go" status of backplane voltages in VME, VME64x, VXI, CompactPCI, and similar systems. The monitor can be "hard wired" into the chassis, which avoids wasting a card slot. Monitoring up to eight voltages, the monitor sends signals indicating Failure when a voltage falls within two threshold voltages set by the input resistors. There are four optional LED drivers for indicating the status of fans, temperature sensors, etc. The unit monitors voltages of +5V, -5.2V, +/-12V, +3.3V, +/-24V, -2.0V and can drive up to 12 LEDs (bi-color or single color). Built-in hysteresis prevents LED "chatter".



SYSTEM MONITOR ONLINEPRO

- Up to 8 voltages
- Monitors up to 14 temperature sensors
- Monitor and control up to 12 fans
- Ethernet interface: TCP/IP HTTP, Telnet protocol supported
- RS232 serial interface
- User configurable I/O pins

Order Number CAE018411

The Sysmon OnlinePRO (SOP) is a platform-independent system monitoring unit which monitors- and, if necessary, controls - the internal parameters of a System Platform such as voltages, temperatures, digital inputs and fan speeds. The unit uses a 16-bit micro-controller with an integrated 12-bit A/D converter and suitable peripheral circuitry.

Any limit infringements (high or low) occurring for voltages V1 to V4, temperature and fan minimum speed are signaled via the front-panel LEDs. If indication of more than 4 voltages is required, the ELMA LED display (p/n CAE020004) can be connected to the SOP as an accessory and installed at any position in the system.

The measured values are retrievable at any time via the RS232 serial interface and via Telnet. In addition, limits and system parameters can be changed at any time with the unit in service. As a result, the SOP – and hence the connected system - can be controlled and monitored online via any computer with an Internet connection.

Related Products - Other

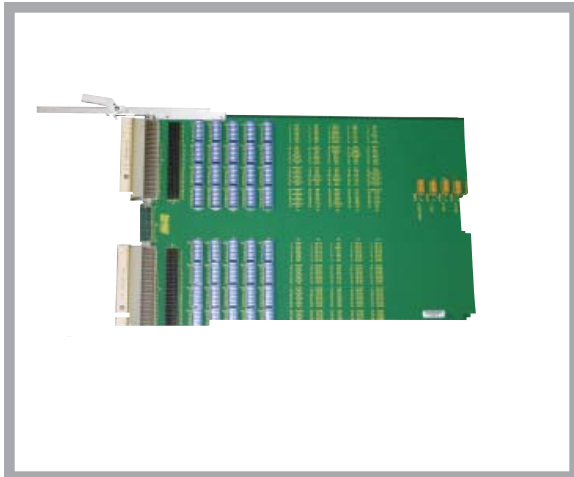

EXTENDER BOARDS

- Versions for VME, VME64x, VXI, VXS, cPCI and ATCA
- Designed to meet applicable ANSI/VITA or PICMG specifications
- High-performance stripline design
- Individual switch isolation
- Designed to bring a circuit card completely out of a card cage for testing and debugging
- VME versions in 3U x 60mm, 6U x 60mm, 6U x 120mm, or 6U x 180mm
- VME64x and VXS version in 6U x 220mm
- VXI version in 6U x 340mm
- cPCI version in 6U x 400mm
- ATCA version in 8U x 500mm

LOAD BOARDS

- Versions for cPCI and VME/VME64x
- Conforms to latest VITA or PICMG specifications
- Aids in thermal and power characterization, locating hot spots
- Visual GO/NO-GO indicators
- Power supply loading varies with binary switches in front panel

FORM FACTOR EXTENDERS

- Versions for VME and VME64x
- Conforms to latest VITA specifications
- VME versions in 3U x 60mm, 6U x 60mm, 120mm, or 180mm
- VME64x versions in 6U x 60mm and 6U x 180mm

POWER INTERFACE BOARDS

- Versions in 3U or 6U heights
- Designed to comply with power interface specification PICMG 2.11 Rev.1.0 and IEEE 1101.10 mechanical specification
- One or two pluggable 47-pin power connectors
- Header for voltage sense, current share, and IPMB
- Power taps for +5V, 3.3V, GND and faston



RUGGED CABINETS

- Build to print or custom designs
- Shock, vibration and seismic designs
- EMI/RFI shielding
- Thermal management
- Custom panels and cutouts
- Special paint and finishes
- Silkscreening and marking
- Custom packaging and pallets
- Optional crane lifting eyes support 1000 lbs. each
- 3-dimensional support braces
- Heavy-duty door hinges
- Removable bottom panel
- Retractable stabilizer

Testing/design verification for shock and vibration, EMC and thermal management.

- MIL-STD-901D Shipboard shock
- MIL-STD-108E Basic requirements for enclosures
- MIL-STD-167-1 Mechanical vibrations
- MIL-STD-801F Environmental

Contact Optima EPS at (770) 496-4000 or visit www.elma.com for more information on Rugged Cabinets.

Customization



Elma Electronic has been designing custom chassis solutions for the embedded systems market for over 20 years. Our highly experienced team of engineers have expertise in mechanical and electrical enclosure design with emphases on; thermal management, EMC, shock/vibration, system monitoring, reliability and maintainability.

Our engineers start with a solid foundation of quality Elma components and proven design concepts to reduce develop time/cost and insure compliant solutions regardless of the application. Using the latest in 3D solid modeling, thermal analysis, structural analysis and backplane simulation software, Elma designers are able to verify the performance of their designs without the time and expense of repeated prototyping, combined with a dynamic product lifecycle management (PLM) system



Rugged COTS Applications



APPLICATION EXAMPLES

- JSF - Joint Strike Fighter, International
- Visby Class Corvette, Sweden
- THAAD - Theatre High Altitude Area Defense Missile System, USA
- SSDS - Ship Self-defense System
- Seawolf Submarine, TARPU
- Avionics Instrument Sensors development and testing for Joint Strike Fighter Program
- Point Target stand-off Missile

Elma COTS chassis have been proven to perform in multiple real world Military and Defense applications. Selected for use in a wide range of Airborne, Shipboard, and Ground mobile programs, Elma's 12R1, 12R2, 12RC and ATR chassis provide a reliable platform for mission critical applications. Elma's knowledge of harsh environments combined with 40 years of enclosure design experience ensures the performance of our units to meet your next requirement.



Verification Testing

Elma offers a wide range of services to assist our customers with new product introduction (NPI). From custom design and verification testing through agency certification, Elma has the experience to function as an extension of your company's design and compliance engineering team. Combined with Elma's level 4/5 integration capability for both embedded systems and switches. Elma provides a single solution to your outsourcing needs. Allow Elma to take your latest product from prototype to production quickly, cost effectively and with reduced risk.

Customization is the standard at Elma. With an extensive offering of modular products as a foundation, Elma is able to leverage existing solutions and proven design concepts to meet any custom application. This approach ensures that Elma will provide quality, complaint solutions with significantly reduced lead time, cost and risk. Elma uses the most advanced software and testing equipment to ensure our products comply with military and commercial standards. Elma has the capability to perform environmental testing, thermal testing and EMC testing to meet the desired specifications.

Elma has the capability to undertake and oversee design verification testing to ensure that your/our products comply with the following military or commercial standards depending on the specification requirements.

- Shock and Vibration Testing to meet MIL STD-810E, MIL-STD-167 and MIL-STD-901D
- EMC testing to meet MIL-STD-461D, FCC class A, FCC class B and CE emissions
- NEBS testing to meet levels 1, 2 and 3
- In house cooling analysis and testing to meet thermal requirements
- Environmental testing: Temperature, Humidity, Fungus, etc.
- Preliminary Reliability analysis per MIL-HDBK-217F



PRE-SCANNING FOR RADIATED EMISSION

- Computer controlled Spectrum Analyzer.
 - 10KHz to 1GHz coverage
 - CISPER 16 compliant
 - Auto compensation to test site errors.
- Broadband Receiving antenna.
 - 30MHz to 1GHz Frequency Range.
 - Calibrated at National Physics Lab in U.K.
 - Preamplifier
 - Vertical and Horizontal.
- Emission Reference Source.
 - Used to calibrate the system to site conditions.
 - Calibrated at National Physics Lab in U.K.
- EMC software designed for use with the Spectrum Analyzer.
- Near Field EM probes to help pinpoint trouble spots.



POWER SUPPLY TESTING AND QUALIFYING

Elma pre-qualifies the standard power supplies used in standard Elma chassis.

- Verify voltage outputs under low and high load conditions.
(+5%/-3% for 3.3 and 5VDC, +/-5% for +/-12VDC)
- Verify noise level for all outputs, under various load conditions.
(50mV P-P for 3.3 and 5VDC, 120mV P-P for +/- 12VDC)
- Check for excessive drift on all outputs, under various load conditions, during a 48-hour burn in cycle.

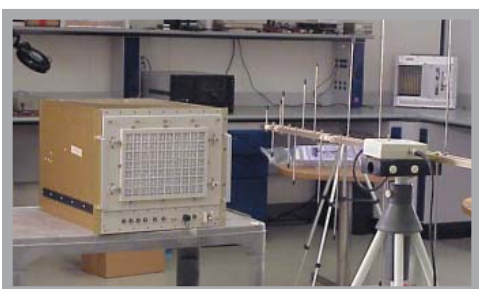

Verification Testing

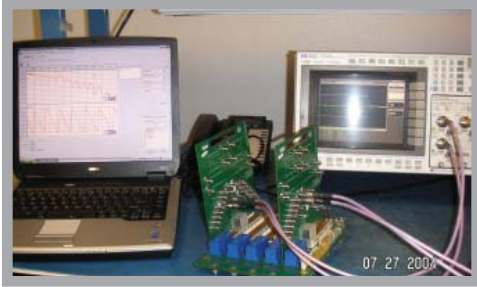

STRUCTURAL ANALYSIS

- Shock
- Crash load
- Resonance frequencies

BACKPLANE SIGNAL INTEGRITY STUDIES

- Backplane characterization measures the real signal integrity of the backplane
- Ensures backplane will perform as expected before shipment
- Simulation characteristics include impedance, cross-talk, propagation delay, attenuation, insertion & return loss and eye diagram

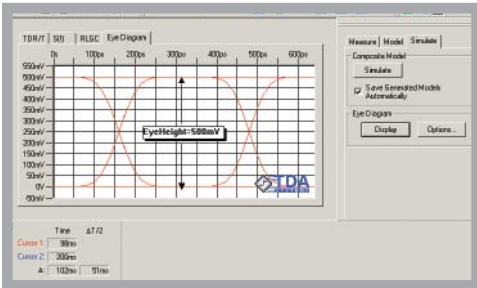

AIRFLOW AND THERMAL ANALYSIS

- Model flow behavior for entire system
- Identify performance-limiting components
- Quick evaluation of different physical layouts
- Explore many different design options
- Perform “what-if” studies
- Avoid costly design changes

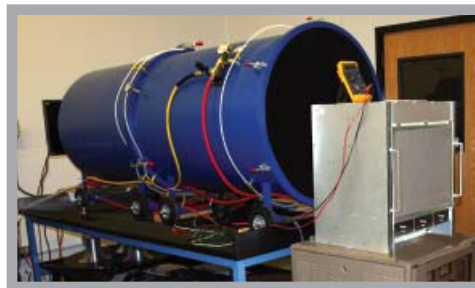

THERMAL SIMULATION

Elma's Thermal Simulation can be extremely helpful in coming up with an optimal rugged COTS chassis cooling solution. Elma can simulate specifically how your boards interact with the chassis in regards to the cooling. After modeling your card, Elma's designers can verify the cooling and make sure the hotter components of the card are placed in cooler parts of the chassis. If the per slot loading is provided, thermal simulation could be performed where baffles or extra fans could be added to ensure proper cooling for all boards.

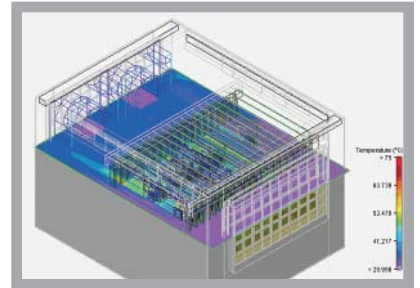

Using CFD-based (Computation Fluid Dynamics) thermal modeling software like FlowTherm, Elma can change the intake and exhaust areas, change fans and fan configuration, add and optimize baffling and monitor the temperature at critical locations before fabricating and testing a chassis. Simulation can help determine the proper fans to use in order to ensure proper chassis cooling as well as keeping the audible noise level at a minimum. Other ways to optimize the chassis thermal management are the spacing for air intake and exhaust, types of fans and blowers, the plenum space above or below the fans, the placement of air filters and use of baffles. Locating hot spots in the chassis, the designer can simulate options to rectify the situation. For example, a baffle can be placed in a particular area to direct airflow, or changing a fan's position to increase or decrease the air plenum. A different type of fan or blower can also be used to improve the results.

Simulation can also help maximize the usefulness of the shelf managers. Thermal analysis can show how a shelf manager can tie or group fans together to optimize airflow when it senses a problem. It can also help determine the ideal sequence in timing solution for shutting down cards, which signals to send, and when it is absolutely necessary to shut down the entire system. For example, if there is a problem, perhaps only a few cards need to be shut down instead of all of them. Contact Elma at (510) 656-3400 for more information on our Thermal Simulation services.

MIL-STD Testing

MIL-STD-167, Shipboard Vibration

MIL-STD-167 (MS167) tests a unit in each axis over the range of 4-50Hz. The range has been specified by the MS167 as the normal frequency range of shipboard applications. A unit under test (EUT) is fixed-mounted to a slip table (in the transverse side-to-side axis and longitudinal front-to-back axis) or mounted directly to a plate on top of the shaker (in the vertical axis bottom to top). The input at each frequency is defined by a table displacement tabulation in MIL-STD-167.

There are three parts to MIL-STD-167: exploratory sweep (15s and each 1Hz interval between 4-50Hz), variable dwell (5min and each 1Hz interval between 4-50Hz), endurance dwell (2hr dwell at resonant frequency).

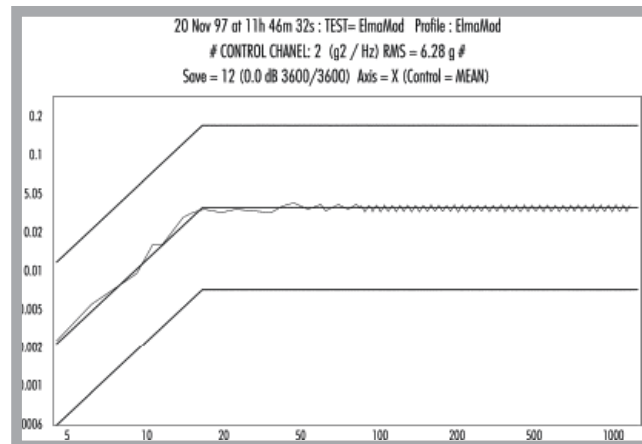

In addition to the above procedures, a continuous 5 or 15 minute sweep is usually performed across the entire 5-50Hz range before the MIL-STD-167 exploratory sweep. This continuous sweep is much more useful than any of the MIL-STD-167 tests in identifying the true resonant frequencies of a system. In general, this sweep is the basis for choosing the endurance dwell frequency.

MIL-STD-810F, Shock

MIL-STD-810F tests the response of a unit to an individual shock pulse. In each axis, 3 positive and 3 negative (1/2 sine) pulses are applied to the EUT. The duration of the shock pulse is defined by MIL-STD-810F for each input level.

12R2 Shock & Vibration Testing

MIL-STD-810F structural integrity tests the response of a unit, in each axis, to a random vibration input over the frequency range of 5-2000 Hz.

The purpose of the structural integrity test is to see if the EUT will survive mechanically after being submitted to the random vibration profile for 1 hour in each axis. Although the test does not measure acceleration or transmissibility levels, it does plot the power spectral density profile of the system over the frequency range.

MIL-S-810F, Structural Integrity Vibration

During the development of the 12R2 product line, Elma's engineering R&D department conducted multiple tests to ensure that the 12R2 design meets the requirements for the intended applications.

Prototypes sized 9U x 22", went through MIL-STD-167 vibration and MIL-STD-810F shock from 15G to a maximum of 35G. The 12U x 25" prototypes went through MIL-STD-810F shock from 25G-30G and MIL-STD-810F random structural integrity vibration.

Based on the exceptional results of the base design during the first run of tests (complete and abbreviated test reports are available), the second round of testing focused on the effect of shock and vibration on critical items within the chassis. Accelerometers positioned in the chassis during the first round of testing determined the transmitted input to these components. Based on these inputs, tests performed on various power supplies, drives and isolation assemblies helped determine the optimal configurations and best components for the 12R2 product line. Complete test reports are available by request.

System Integration



INTEGRATION SERVICES

- Adding Peripherals
- Installing SBC's
- Loading Software
- Fully wired and tested
- Shock and vibration testing
- EMC and NEBS testing
- Thermal analysis
- FCC Class A and B certification
- UL, CSA, CE certification
- NEBS Level III certification

By allowing Elma to combine your system platforms with third party active components such as; single board computers (SBC), peripherals, I/O cards and cabling you can greatly reduce your logistics and over cost of your project. Elma has strategic relationships with most major SBC and blade manufactures and our Systems Integration Engineers routinely attend training seminars to insure that they are up to date on the latest technology advancements. Elma's experience with shelf management insures that all system level monitoring of field replaceable units (FRU) is handle seamlessly. Combined with any of the major operating systems (OS) and application specific software, Elma can integrate, test and ship your completed product, turnkey and ready to run.

WHY USE ELMA INTEGRATION

- Chassis Platform experts: Configuration, cooling, shock/vib, EMC, NEBS
- System Architect experts for: VME, CPCI, ATCA, and MicroTCA
- In-House Manufacturing and Assembly
- SBC Agnostic
- Software Development Systems and Tools
- Pricing, Buying Leverage
- Low volume custom solutions
- Logistics Support
- System Testing
- Obsolescence and EOL Tracking
- Global partner

BENEFITS

- Reduced per unit and program costs
- Improved solution quality
- Improved time to market
- Rapid response to market trends
- Increased Customer focus on core competency



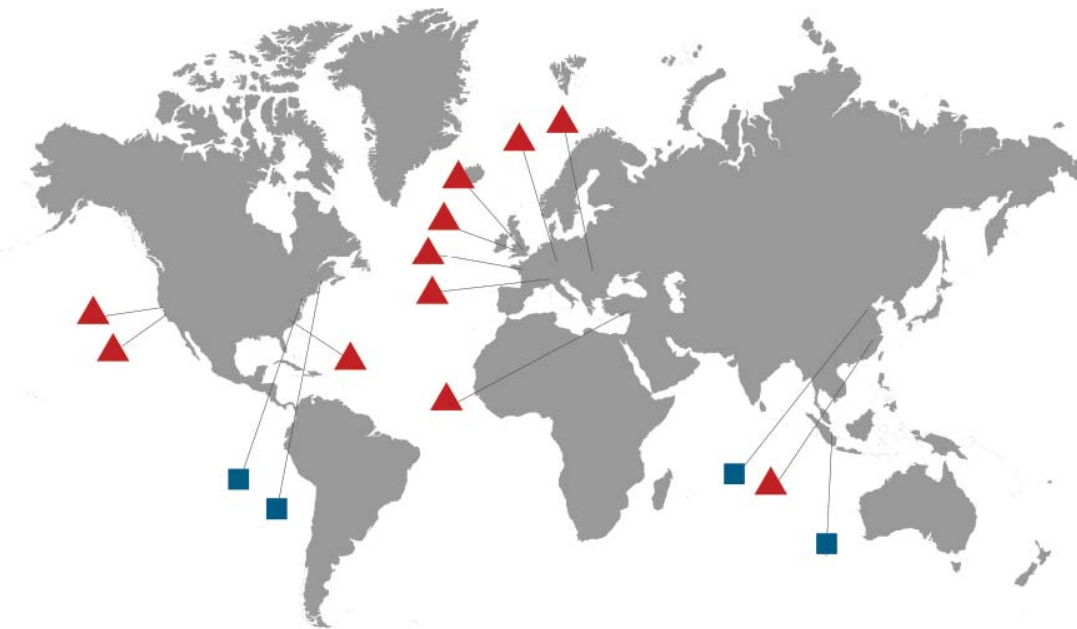

 Elma Sales Office

 Elma Production/Assembly/Sales

UNITED STATES, ELMA ELECTRONIC

Elma Electronic US Headquarters
44350 Grimmer Blvd.
Fremont, CA 94538
Phone: (510) 656-3400
Fax: (510) 656-3783
sales@elma.com
www.elma.com

Elma Electronic/Northeast
9 Summer Street, Suite 303
Franklin, MA 02038
Phone: (508) 541-5770
Fax: (508) 541-5444
sales@elma.com
www.elma.com

ELMA BUSTRONIC

Elma Bustronic Headquarters
44350 Grimmer Blvd.
Fremont, CA 94538
Phone: (510) 490-7388
Fax: (510) 490-1853
sales@elmabustronic.com
www.elmabustronic.com

ELMA ELECTRONIC/OPTIMA

Elma Electronic/Optima EPS
2166 Mountain Industrial Blvd.
Tucker, GA 30084
Phone: (770) 496-4000
Fax: (770) 496-4041
sales@elma.com
www.elma.com

SWITZERLAND

Elma Electronic AG
Hofstrasse 93, Postfach
620 Wetzikon
Phone: +41 44 933 41 11
Fax CH: +41 44 933 42 15
Fax Inter: +41 44 932 38 12
sales@elma.ch
www.elma.com

CHINA

Elma Electronic China
8F, 355, Fu Te Road (West 1)
Wai Gao Qiao Free Trade Zone
Pudong District, Shanghai, 200131, China
Phone: +86 21 5866 5908
Fax: +86 21 5866 5918
sales@elmachina.com
www.elma.com

GERMANY

Elma Trenew Electronic GmbH
Stuttgarter Strasse 11
75179 Pforzheim
Phone: +49 7231 97 340
Fax: +49 7231 97 3497
info@elma.de
www.elma.com

UNITED KINGDOM

Elma Electronic UK Ltd
Solutions House, Fraser Road
Priory Business Park, Bedford
MK44 3BF
UK
Phone: +44 (0)1234 838822
Fax: +44 (0)1234 761335
sales@elma-electronic.co.uk

ISRAEL

Elma Electronic Israel Ltd.
34, Modi'in St.
IL-I.Z. Sgula Petach Tikva 49271
Phone: +972 3 930 5025
Fax: +972 3 931 3134
sales@elma.co.il
www.elma.com

FRANCE

Elma Electronic France SASU
ZA du Buisson Rond
38460 Villemoirieu
Phone: +33 4 37 06 21 10
Fax: +33 4 37 06 21 19
sales@elma-electronic.fr
www.elma.com

ROMANIA

Elma Electronic SRL
Str. Maltopol Nr.16
011048 Bucuresti, Romania
Phone +4021 310 7998
Fax +4021 310 7992
info@elma.ro
www.elma.com